



COMPONENTI PER GAS



COMPONENTI ELETTRICI



COMPONENTI PER ACQUA



COMPONENTI MECCANICI



UTENSILI

Ricambi adatti a

VULCAN

Per la gamma completa sempre aggiornata visitate il nostro internet shop



Catalogo dei produttori

Per ciascun produttore, le parti di ricambio e gli accessori sono elencati in modo chiaro

- ✓ Assortimento completo e tutti i dati degli apparecchi sempre aggiornati nel Internetshop GEV
- ✓ Indice alfabetico alla fine del catalogo

Internetshop GEV Fast ricambi

www.fastricambi.it



- 🔍 Segna articolo come preferito
- 🔍 Procedi al log-in inserendo l'indirizzo mail e la password
- 🔍 Ordine Comfort – carica nel carrello una lista di articoli
- 🔍 Cerca ricambi in Cercafacile senza bisogno del log-in



interruttori e pulsanti

interruttori/pulsanti basculanti

37x21mm



1

codice	348098 ¹	cod. costr.	00-358628-0001 358628-0001 358628-1
descrizione	interruttore basculante dimensioni di montaggio 37x21mm nero 2CO 250V 10A con posizione neutra attacco Faston maschio 6,3mm temperatura ambiente max. 125/55°C protezione IP55		

¹con posizione neutra

lampade

lampade spia

lampade spia complete

ø12mm

con attacco a innesto



1

codice	580014	cod. costr.	843808 844367-7
descrizione	lampada spia ø12mm 230V rosso		

contattori

HARTLAND

contattori di potenza

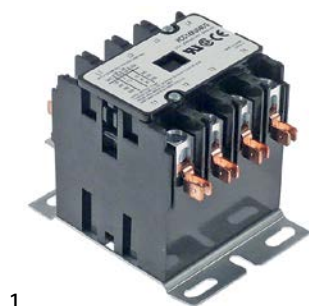

1

codice	580012	cod. costr.	111497D3 411497D3 844329 853270
descrizione	contattore carico nominale AC1 50A 240VAC 40A/10HP (AC3/240V) 40A/7,46kW contatti principali 4NO attacco morsetto a vite/Faston maschio 6,3mm tipo HCCY4XU04CG		

valvole del gas e centraline di accensione





valvole di regolazione gas

ROBERTSHAW

controllo elettrico



1

codice	101429	cod. costr.	470841-3	
descrizione	valvola per gas aliment. 120V 50/60Hz entrata gas 3/4" uscita gas 3/4" attacco per termocoppia 3/8" NEF collegamento pilota 1/4" tubo americano tipo 7000BMSER-120 pressostato metano 3,5" W.C. adattabile a ROBERTSHAW			
ricambi per	101429			
	codice	101047	cod. costr.	—
	gruppo magnetico F1: ASA 11/32 F2: M24x1 L 59mm ø 4mm adattabile a ROBERTSHAW			
	codice	101389	cod. costr.	—
	regolatore di pressione gas naturale adattabile a ROBERTSHAW			
	codice	580033	cod. costr.	—
	manopola adattabile a ROBERTSHAW			
accessori per	101429			
	codice	580035	cod. costr.	110839-1 410839-1
	termopila L 36" - 915mm bulbo ø 9mm bulbo L 38mm 250-750mV raccordo 7/16" attacco 3/8" NEF			



1













codice	580044	cod. costr.	110841-3 410841-00003 410841-3	
descrizione	valvola per gas alimentazione 120VAC 50/60Hz entrata gas 3/4" NPT uscita gas 3/4" NPT attacco per termocoppia 11/32" collegamento pilota 1/4" CCT tipo 7000BER-120 pressostato metano 3,5" W.C. adattabile a ROBERTSHAW			
ricambi per	580044			
	codice	101047	cod. costr.	—
	gruppo magnetico F1: ASA 11/32 F2: M24x1 L 59mm ø 4mm adattabile a ROBERTSHAW			

Tabella continua alla prossima pagina

ricambi per	580044		
	codice	101389	cod. costr.
	regolatore di pressione gas naturale adattabile a ROBERTSHAW		
	codice	106109	cod. costr.
	vite di serraggio filetto 7/16"-24 UNS per tubo ø 1/4" L 16mm ottone conf. 1 pz CH 7/16" (11,113mm) fori ø 6.4mm		
	codice	580033	cod. costr.
	manopola adattabile a ROBERTSHAW		
accessori per	580044		
	codice	102122	cod. costr.
	termocoppia ROBERTSHAW ASA 11/32 L 18" - 455mm 7/16"		
	codice	102277	cod. costr.
	termocoppia ROBERTSHAW ASA 11/32 L 36" - 915mm 7/16"		

con controllo a gas

	1		
codice	580043	cod. costr.	110841-1 410841-1
descrizione	valvola per gas alimentazione Operator gas entrata 1/4" CCT uscita 1/4" CCT entrata gas 3/4" NPT uscita gas 3/4" NPT attacco per termocoppia 3/8" NEF collegamento pilota 1/4" CCT tipo 7000BMSGOR pressostato metano 3,5" W.C. adattabile a ROBERTSHAW		
ricambi per	580043		
	codice	101042	cod. costr.
	gruppo magnetico F1: 3/8" NEF adattabile a ROBERTSHAW per operatore gas		
	codice	101481	cod. costr.
	anello bicono per tubo ø 1/4" CCT conf. 1 pz		
	codice	106109	cod. costr.
	vite di serraggio filetto 7/16"-24 UNS per tubo ø 1/4" L 16mm ottone conf. 1 pz CH 7/16" (11,113mm) fori ø 6.4mm		
	codice	580033	cod. costr.
	manopola adattabile a ROBERTSHAW		
accessori per	580043		
	codice	580035	cod. costr.
	termopila L 36" - 915mm bulbo ø 9mm bulbo L 38mm 250-750mV raccordo 7/16" attacco 3/8" NEF		

accensioni e termocoppie

bruciatori pilota

ROBERTSHAW

bruciatori pilota

serie universale - tipo 2









1

codice	107402	cod. costr.	109839-1 109839-3 409839-1 409839-3 409839-3 (LP) / 409839-1 (NAT)
descrizione	bruciatore pilota ROBERTSHAW tipo 2C-2 1-fiamma gas naturale/GPL indice 18/10 per tubo ø 1/4" CCT		



1

codice	100117	cod. costr.	112787-1 412787-1 412787-1 (NAT)
descrizione	bruciatore pilota ROBERTSHAW tipo 2CH-1 1-fiamma gas naturale indice 18 per tubo ø 1/4" CCT		
accessori per	100117		
	codice	100275	cod. costr.
	ugello per bruciatore pilota gas liquido indice 10 foro ø 0.1mm adattabile a ROBERTSHAW		
	codice	100276	cod. costr.
	ugello per bruciatore pilota gas naturale indice 18 adattabile a ROBERTSHAW		
	codice	100277	cod. costr.
	ugello per bruciatore pilota gas naturale indice 26 adattabile a ROBERTSHAW		
	codice	101286	cod. costr.
	anello bicono int. ø 6mm conf. 1 pz		
	codice	101481	cod. costr.
	anello bicono per tubo ø 1/4" CCT conf. 1 pz		
	codice	101483	cod. costr.
	ghiera filetto 1/4" CCT corto		







serie universale - tipo 3

			
1			
codice	107398	cod. costr.	112082-1 112082-2 412082-1 412082-1 (NAT) / 412082-2 (LP)
descrizione	bruciatore pilota ROBERTSHAW tipo 3CH-10 2-fiamme gas naturale/GPL indice 16/10 per tubo ø 1/4" CCT		
ricambi per	107398		
	codice	100275	cod. costr. 109839-6
	ugello per bruciatore pilota gas liquido indice 10 foro ø 0.1mm adattabile a ROBERTSHAW		
	codice	106105	cod. costr. —
	ugello per bruciatore pilota gas liquido indice 16 adattabile a ROBERTSHAW		

serie universale - tipo 6

Larghezza delle testine:
 6CH10 = 1" (25,4mm)
 6CH14 = 1½" (38,1mm)
 6CH24 = 2½" (63,5mm)
 6CH30 = 3" (76,2mm)

			
1			
codice	106346	cod. costr.	112212-1 412212-1
descrizione	bruciatore pilota ROBERTSHAW tipo 6CH14-10 3-fiamme gas naturale indice 22 per tubo ø 1/4" CCT attacco gas 1/4" CCTmm		

			
1			
codice	107396	cod. costr.	805925-11 F5925-11
descrizione	bruciatore pilota ROBERTSHAW tipo 6CH24-6 3-fiamme gas naturale/GPL indice 16/26 per tubo ø 1/4" CCT		
ricambi per	107396		
	codice	100277	cod. costr. —
	ugello per bruciatore pilota gas naturale indice 26 adattabile a ROBERTSHAW		
	codice	106105	cod. costr. —
	ugello per bruciatore pilota gas liquido indice 16 adattabile a ROBERTSHAW		

serie 11EA

			
1			
codice	107412	cod. costr.	00-409125-00001 00-409125-00003 109125-1 109125-3 409125-1 409125-3 729125-1 729125-3
descrizione	bruciatore pilota ROBERTSHAW tipo 11EA 1-fiamma gas naturale per tubo ø 3/16" - 1/4" CCT		

serie Mini Pilot

			
1			
codice	107414	cod. costr.	2693 802693
descrizione	bruciatore pilota ROBERTSHAW tipo 2 2-fiamme gas naturale/GPL indice per tubo ø 3/16" - 1/4" CCT con termocoppia		

bruciatori pilota personalizzati dal costruttore

VULCAN HART

			
1			
codice	107391	cod. costr.	00-410662-000G1 110662G1 112071G1 112073G1 113866G1 410662G1 412071G1 412073G1 421573G4
descrizione	bruciatore pilota 4-fiamme 3/16"		



1

codice	107413	cod. costr.	00-414645-0001 114645-1 414645-1
descrizione	bruciatore pilota tipo 43U4		

termocoppie

set di termocoppie universali



1

codice	102281	cod. costr.	00-412788-0001 112788-1 20040 412788-1 920040
descrizione	set termocoppie ROBERTSHAW 5 pezzi L 24" - 610mm		



1

codice	103236	cod. costr.	00-722248
descrizione	set termocoppie ROBERTSHAW 5 pezzi L 60" - 1525mm ASA 11/32		

termopile

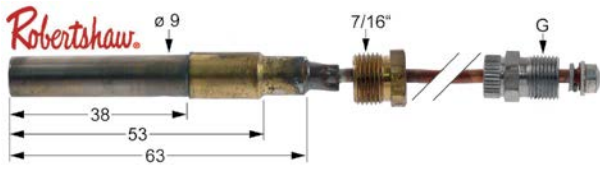

1

codice	580035	cod. costr.	110839-1 410839-1
descrizione	termopila L 36" - 915mm bulbo \varnothing 9mm bulbo L 38mm 250-750mV raccordo 7/16" attacco 3/8" NEF		

accessori

giunti interrotti



1

codice	580046	cod. costr.	00-410838-000G1 110838G1 410838G1
descrizione	prolunga per giunto interrotto L 18" - 455mm		

ugelli del gas

ugelli per bruciatori pilota

ugelli per bruciatori pilota ROBERTSHAW



1

codice	100275	cod. costr.	109839-6
descrizione	ugello per bruciatore pilota gas liquido indice 10 foro \varnothing 0.1mm adattabile a ROBERTSHAW		

cerniere

cerniere piane

varie

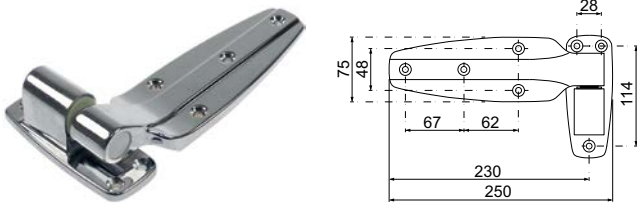

1

codice	701446	cod. costr.	138057-14 430900-1-5
descrizione	cerniera H tot. 54mm con rampa lungh. totale 250mm lar. 75mm		

cesti

cesti per friggitori

produttori USA



1

codice	970183	cod. costr.	OY420563-1
descrizione	cestello friggitrice L1 308mm B1 160mm H1 135mm		

			
1			
codice	970184	cod. costr.	110782-1 111378-2 410782-1 411378-2 420581-1 4900
descrizione	cestello friggitrice L1 330mm B1 315mm H1 135mm		

			
1			
codice	970182	cod. costr.	108654-1 110737-1 110737-7 408654-1 410737-1 410737-7 4712 804712
descrizione	cestello friggitrice L1 340mm B1 165mm H1 150mm L2 620mm H2 280mm		

B

bruciatori pilota 4

C

cerniere piane 6

contattori 3

I

interruttori e pulsanti 3

interruttori/pulsanti basculanti 3

L

lampade 3

lampade spia 3

lampade spia complete 3

T

termocoppie 6

U

ugelli del gas 6

V

valvole di regolazione gas 3