



COMPONENTI PER GAS



COMPONENTI ELETTRICI



COMPONENTI PER ACQUA



COMPONENTI MECCANICI



UTENSILI

Ricambi adatti a

VFA-EXPRESS

Per la gamma completa sempre aggiornata visitate il nostro internet shop



Catalogo dei produttori

Per ciascun produttore, le parti di ricambio e gli accessori sono elencati in modo chiaro

- ✓ Assortimento completo e tutti i dati degli apparecchi sempre aggiornati nel Internetshop GEV
- ✓ Indice alfabetico alla fine del catalogo

Internetshop GEV Fast ricambi



www.fastricambi.it



- 🔍 Segna articolo come preferito
- 🔍 Procedi al log-in inserendo l'indirizzo mail e la password
- 🔍 Ordine Comfort – carica nel carrello una lista di articoli
- 🔍 Cerca ricambi in Cercafacile senza bisogno del log-in

resistenze

resistenze per macchine da caffè

			
1			
codice	417090	cod. costr.	521911/1
descrizione	resistenza 1450W 230V Nr. spirali 1 incasso ø 42mm int. dei fori 74mm L 132mm lar. 36mm H 40mm spire 3 fori ø 10mm tubo ø 6.3mm attacco M6 resistenza ad immersione flangia a 2 fori		
accessori per	417090		
	codice	527156	cod. costr. —
	guarnizione piana PTFE ø est. 57.8mm int. ø 43.3mm spessore 2mm conf. 1 pz		
	codice	528002	cod. costr. —
	guarnizione piana PTFE ø est. 57mm int. ø 42mm spessore 3mm conf. 1 pz cod. prod. 12001/W10470 adattabile a		

			
1			
codice	417077	cod. costr.	N/A
descrizione	resistenza 1450W Nr. spirali 1 resistenza ad immersione flangia a 2 fori		

			
1			
codice	417074	cod. costr.	F...7 N/A
descrizione	resistenza 1800W 230V Nr. spirali 2 incasso ø 42mm int. dei fori 75mm L 235mm lar. 33mm H 33mm L1 25mm L2 40mm L3 170mm fori ø 10mm attacco M4 fissaggio a 2 fori		

			
1			
codice	417078	cod. costr.	N/A
descrizione	resistenza 1800W 400V resistenza ad immersione		

			
1			
codice	417067	cod. costr.	N/A
descrizione	resistenza 2600W 230V flangia a 2 fori resistenza ad immersione		

			
1			
codice	417076	cod. costr.	N/A
descrizione	resistenza 2600W 400V fissaggio a 2 fori resistenza ad immersione		

			
1			
codice	417401	cod. costr.	521906
descrizione	resistenza 3400W 230V Nr. spirali 3 incasso ø 42mm int. dei fori 74mm L 315mm lar. 35mm H 45mm L1 20mm L2 45mm L3 250mm H1 31mm H2 14mm fori ø 10mm tubo ø 8mm attacco M4 resistenza ad immersione flangia a 2 fori		

			
1			
codice	417187	cod. costr.	528302
descrizione	resistenza 3700W 230V Nr. spirali 2 incasso ø 42mm int. dei fori 74mm L 570mm lar. 38mm H 48mm L1 25mm L2 60mm L3 485mm H1 26mm H2 12mm fori ø 10mm tubo ø 8mm attacco M4 resistenza ad immersione flangia a 2 fori		

			
1			
codice	417157	cod. costr.	521908
descrizione	resistenza 5000W 230V Nr. spirali 3 incasso ø 42mm int. dei fori 75mm L 478mm lar. 38mm H 55mm L1 17mm L2 41mm L3 420mm H1 32mm H2 23mm fori ø 10mm tubo ø 8mm attacco M4 resistenza ad immersione flangia a 2 fori		

			
1			
codice	417079	cod. costr.	N/A
descrizione	resistenza fissaggio a 2 fori resistenza ad immersione		

accessori

anelli di tenuta

guarnizioni in fibra

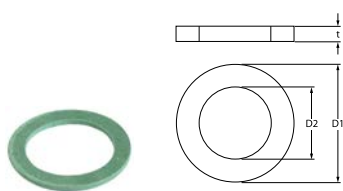
			
1			
codice	528488	cod. costr.	N/A
descrizione	guarnizione piana fibra ø est. 57mm int. ø 42mm spessore 3mm conf. 1 pz		

guarnizioni in PTFE

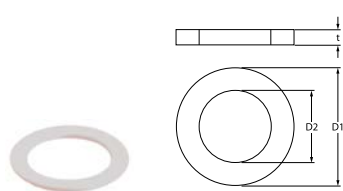
			
1			
codice	528925	cod. costr.	N/A
descrizione	guarnizione piana PTFE ø est. 59.5mm int. ø 42mm spessore 3mm conf. 1 pz adattabile a VFA Express		



interruttori e pulsanti

microinterruttori

azionamento a rotella

rotella 90°



codice	345104	cod. costr.	514316
descrizione	microinterruttore con rullo di pressione 250V 16A 1CO attacco Faston maschio 6,3mm L 24mm temperatura ambiente max. 125°C lungh. fil. 12mm filetto M10x0,75 interasse di fissaggio 22mm forza di azionamento: 280g tipo EF83161.1		

commutatori a rotazione

GOTTAK



codice	345148	cod. costr.	514318
descrizione	commutatore a rotazione 3 0-1-2 gruppi di contatti 6 tipo 4RH 400V 10A alb. ø 4,8x6mm alb. L 21mm alberino ovale attacco Faston maschio 6,3mm		

elettronica

schede elettroniche



codice	531140	cod. costr.	X214665
descrizione	display per macchina caffè L 117mm lar. 45mm adattabile a VFA Expres blu		

tastiere

mascherine frontali



codice	401726	cod. costr.	214671
descrizione	targhetta per tastiere L 130mm lar. 44mm tasti 6		

tastiere a membrana



codice	401589	cod. costr.	N/A
descrizione	tastiera		



codice	401725	cod. costr.	214604 (rojo)
descrizione	tastiera tasti 5 rosso L 105mm lar. 27mm		

tastiere



codice	400378	cod. costr.	N/A
descrizione	tastiera		



codice	400390	cod. costr.	N/A
descrizione	tastiera		

pressostati

per macchine da caffè

ø38mm



codice	541104	cod. costr.	514324
descrizione	pressostato ø 38mm campo di pressione 0,2-1,2bar 10A 250V attacco Faston maschio 6,3mm 1CO raccordo di mandata 1/4"		

elettrodi



codice	401156	cod. costr.	514366
descrizione	elettrodo di livello 1/4" lungh. totale 150mm bulbo L 124mm lungh. capillare isolato 26mm attacco Faston maschio 6,3mm acciaio inox ø 2.5mm		



contatori volumetrici e sensori della pressione di flusso

contatori volumetrici

GICAR



1

codice	400222	cod. costr.	N/A
descrizione	contatore volumetrico filetto 1/4" acciaio inox Faston maschio 2,8mm certificato NSF		



1

codice	400782	cod. costr.	414795
descrizione	contatore volumetrico tubo ø 6mm plastica a spina certificato NSF		

pompe

pompe di aumento pressione II

teste pompe

FLUID-O-TECH



1

codice	500064	cod. costr.	N/A
descrizione	testa pompa PO204 FLUID-O-TECH L 82mm 200l/h attacco 3/8" GAS con by-pass ottone raccordo a fascetta per macchine del caffè alb. ø 4,8x11mm		

accessori per 500064



codice	520126	cod. costr.	—
fascetta per motore/pompa			

protezioni elettriche

fusibili



1

codice	358676	cod. costr.	214606
descrizione	fusibile misura ø5x20mm 3.15A rapido nominale 250V conf. 10 pz		

ricambi per apparecchiature specifiche

per macchine da caffè

portafiltri

filtri

per 1 tazza



1

codice	526069	cod. costr.	514358
descrizione	filtro caffè ø 70mm incasso ø 60mm H 20.5mm tazza 1 quantità di caffè 7g perforazione ø 0.4mm		



1

codice	529011	cod. costr.	E514358
descrizione	filtro caffè ø 70mm incasso ø 60mm H 24.5mm tazza 1 quantità di caffè 7g perforazione ø 0.4mm		

per 2 tazze



1

codice	526067	cod. costr.	514357
descrizione	filtro caffè ø 70mm incasso ø 60mm H 20.5mm tazza 2 quantità di caffè 12g		

1



codice	526068	cod. costr.	E514357
descrizione	filtro caffè ø 70mm incasso ø 60mm H 24.5mm tazza 2 quantità di caffè 14g		

gruppi erogatori
setacci doccia
con alzatina

1



codice	526788	cod. costr.	528369
descrizione	filtro doccia ø 58mm H 17.5mm		

guarnizioni portafiltro
piane
standard

1



codice	528030	cod. costr.	528370
descrizione	guarnizione portafiltro D1 ø 72.7mm D2 ø 57.2mm H 8mm conf. 1 pz		

distributori d'acqua
distributori d'acqua
gruppo 2

1



codice	529081	cod. costr.	528368
descrizione	distributore d'acqua ø 30mm fori ø 1.5mm H 15mm M M10x1 scanalature 6 2.5mm ottone		

valvole ad espansione
con valvola di non ritorno

1



codice	529323	cod. costr.	528235
descrizione	valvola ad espansione attacco 3/8" con valvola di non ritorno		

vaschette di scarico
vaschette di scarico

1



codice	525206	cod. costr.	314342
descrizione	vaschetta di scarico L 65mm lar. 65mm H 47mm tubo ø 21mm		

rubinetti acqua/vapore
rubinetti acqua/vapore
rubinetti acqua/vapore

1



codice	529850	cod. costr.	528534CO
descrizione	rubinetto per vapore e acqua entrata 1/4" uscita 3/8" ottone		

componenti
corpi valvola

1



codice	528929	cod. costr.	528535CO
descrizione	corpo valvola		

tubo per vapore/acqua			
tubi per acqua			
			
1			
codice	529853	cod. costr.	528377
descrizione	tubo per acqua		

valvole di riempimento			
valvole di riempimento			
			
1			
codice	525207	cod. costr.	528250
descrizione	valvola di riempimento ottone entrata 1/4" uscita 1/4"		

accessori			
varie			
			
1			
codice	531075	cod. costr.	528251
descrizione	corpo valvola per valvola di riempimento		

manopole

rubinetti acqua/vapore			
rubinetti acqua/vapore			
			
1			
codice	111174	cod. costr.	314001R
descrizione	manopola ø 50mm bordeaux		

			
1			
codice	111173	cod. costr.	314001N
descrizione	manopola ø 50mm nero		

accessori			
			
1			
codice	111173	cod. costr.	314001N
descrizione	manopola ø 50mm nero		

guarnizioni

anelli di tenuta			
guarnizioni in fibra			
			
1			
codice	528488	cod. costr.	N/A
descrizione	guarnizione piana fibra ø est. 57mm int. ø 42mm spessore 3mm conf. 1 pz		

guarnizioni in PTFE			
			
1			
codice	528925	cod. costr.	N/A
descrizione	guarnizione piana PTFE ø est. 59.5mm int. ø 42mm spessore 3mm conf. 1 pz adattabile a VFA Express		

guarnizioni speciale

gruppi di guarnizioni			
			
1			
codice	528172	cod. costr.	N/A
descrizione	guarnizione di gruppo L 79mm lar. 71mm spessore 2mm int. dei fori 54mm adattabile a VFA Express		

manometri

			
1			
codice	541578	cod. costr.	N/A
descrizione	manometro scala doppia ø 60mm campo di pressione 0-2,5 / 0-16bar attacco dietro filetto 1/8"		

componenti di fissaggio

dadi

dadi esagonali

dadi esagonali con filetto in pollici



1

codice	503042	cod. costr.	514326
descrizione	dado filetto 3/8" H 6mm ottone CH 22 conf. 1 pz		

materiale di consumo

protezioni elettriche

fusibili



1

codice	358676	cod. costr.	214606
descrizione	fusibile misura ø5x20mm 3.15A rapido nominale 250V conf. 10 pz		

A

anelli di tenuta 7

C

commutatori a rotazione 4

componenti di fissaggio 8

contatori volumetrici 5

D

dadi 8

dadi esagonali 8

E

elettrodi 4

F

fusibili 8

I

interruttori e pulsanti 4

M

materiale di consumo 8

microinterruttori 4

P

pompe 5

pompe di aumento pressione II 5

pressostati 4

protezioni elettriche 5, 8

R

resistenze 3

resistenze per macchine da caffè 3