



COMPONENTI PER GAS



COMPONENTI ELETTRICI



COMPONENTI PER ACQUA



COMPONENTI MECCANICI



UTENSILI

Ricambi adatti a

SHARP

Per la gamma completa sempre aggiornata visitate il nostro internet shop



Catalogo dei produttori

Per ciascun produttore, le parti di ricambio e gli accessori sono elencati in modo chiaro

- ✓ Assortimento completo e tutti i dati degli apparecchi sempre aggiornati nel Internetshop GEV
- ✓ Indice alfabetico alla fine del catalogo

Internetshop GEV Fast ricambi

www.fastricambi.it



- 🔍 Segna articolo come preferito
- 🔍 Procedi al log-in inserendo l'indirizzo mail e la password
- 🔍 Ordine Comfort – carica nel carrello una lista di articoli
- 🔍 Cerca ricambi in Cercafacile senza bisogno del log-in





termostati

termostati a contatto

termostati a contatto

 <p>1</p>			
codice	390632	cod. costr.	RTHM-A122WRZZ
descrizione	termostato a contatto int. dei fori 23.5mm temp. intervento 125°C 1NC 1 poliAV attacco F6,3 fissaggio a 2 fori		

 <p>1</p>			
codice	390634	cod. costr.	RTHM-A120WRE0
descrizione	termostato a contatto int. dei fori 23.5mm temp. intervento 145°C 1NC 1 poli 16A 250V attacco F6,3 fissaggio a 2 fori		

 <p>1</p>			
codice	390635	cod. costr.	QFS-TA014WRE0
descrizione	termostato a contatto int. dei fori 24mm temp. intervento 150°C NC 1 poli 15A attacco F6,3 fissaggio a 2 fori		

interruttori e pulsanti

microinterruttori

azionamento a perno

 <p>1</p>			
codice	347043	cod. costr.	QSW-MA086WRE0 QSW-MA111WRE0
descrizione	microinterruttore con perno 250V 16A 1NC attacco Faston maschio 4,8mm temperatura ambiente max. 105°C interasse di fissaggio 22mm tipo V-16G-2C25 forza di azionamento: 140g nero		

encoder e potenziometri

 <p>1</p>			
codice	401677	cod. costr.	DPWBFC373WRKZ DPWBFC373WRKZ1
descrizione	encoder per microonde		

 <p>1</p>			
codice	401678	cod. costr.	RVR-BA018WRE0
descrizione	encoder per microonde		

lampade

lampade per microonde

lampadine

 <p>1</p>			
codice	359549	cod. costr.	RLMPTA028WRE0 RLMPTA078WRE0
descrizione	lampadina attacco E14 220-240V 25W ø 25mm L 60mm conf. 1 pz per microonde		

magnetron

 <p>1</p>			
codice	402121	cod. costr.	2M240H(L2) RV-MZA299WRE0
descrizione	Magnetron tipo 2M240H(L2)		

 <p>1</p>			
codice	402119	cod. costr.	2M281-39K 2M281H(L) RV-MZA335WRZZ
descrizione	Magnetron tipo 2M281H(L)		

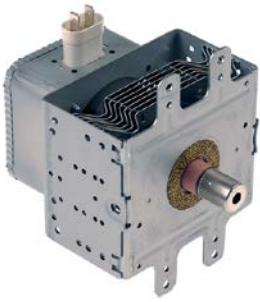

			
1			
codice	402120	cod. costr.	2M282H(L) RV-MZA322WREZ
descrizione	Magnetron tipo 2M282H(L)		

trasformatori

trasformatori aperti

con raccordo cavi

			
1			
codice	402131	cod. costr.	RTRNPA005WRZZ
descrizione	trasformatore primaria 230VAC secondaria 12VAC 60VA secondaria A H 50mm L 45mm lar. 74mm attacco cavo 50/60Hz tipo RTRNPA-005WRZZ		

trasformatori ad alta tensione

			
1			
codice	402130	cod. costr.	RTRN-A717WRZZ
descrizione	trasformatore ad alte tensione primaria 230/240V 50Hz tipo RTRN-A717WRZZ per microonde		

			
1			
codice	402129	cod. costr.	RTRN-A741WRZZ
descrizione	trasformatore ad alte tensione primaria 235V 50Hz tipo RTRN-A741WRZZ per microonde		

			
1			
codice	402128	cod. costr.	RTRN-A742WRZZ
descrizione	trasformatore ad alte tensione primaria 235V 50Hz tipo RTRN-A742WRZZ per microonde		

sonde

sonde personalizzate dal costruttore

			
1			
codice	379521	cod. costr.	FH-HZA070WRE0
descrizione	sonda di temperatura Pt100 cavo fibra di vetro bulbo -100 a +450°C cavo -50 a +350°C attacco spina a connettore filetto bulbo ø3,5x-10mm lunghezza del cavo 0.2m		

elettronica

accessori

			
1			
codice	401044	cod. costr.	GMADIA067WRF0
descrizione	disco H 36mm lar. 82mm plastica		

raddrizzatori

			
1			
codice	401888	cod. costr.	FW-QZA117WRK0
descrizione	raddrizzatore per microonde		

schede elettroniche

			
1			
codice	401048	cod. costr.	FPWBFA367WRKZ
descrizione	scheda elettronica microonde R15 tipo FPWBFA367		

1

codice	401046	cod. costr.	FPWBFA335WRE0
descrizione	scheda elettronica microonde R23 tipo 06XA335A		

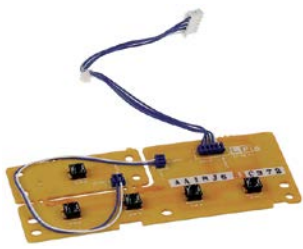

1

codice	401047	cod. costr.	DPWBFC372WRKZ
descrizione	scheda elettronica microonde R25 tipo AA18J6FC372		

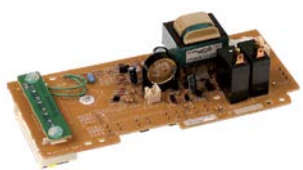

1

codice	401024	cod. costr.	DPWBFC157WRKZ
descrizione	scheda elettronica con display microonde R15 tipo DPWBFC157WRKZ		

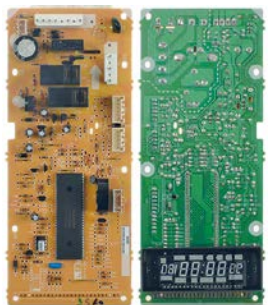

1

codice	401014	cod. costr.	DPWBFC482WRKZ DPWBFC482WRKZ1
descrizione	scheda elettronica con display microonde R23		



1

codice	401043	cod. costr.	DPWBFC484WRKZ
descrizione	scheda elettronica con display microonde R23		



1

codice	401045	cod. costr.	DPWBFC366WRKZ DPWBFC366WRKZ1
descrizione	scheda elettronica con display microonde R25		

tastiere

tastiere a membrana

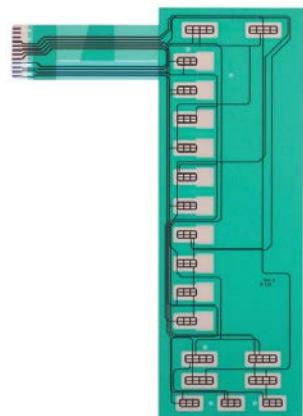

1

codice	402162	cod. costr.	QSWKA041DRZZ
descrizione	tastiera L 242mm lar. 86mm		

pannelli comandi



1	codice	401866	cod. costr.	FPNLB774WRKZ
	descrizione	pannello comandi		

ventilatori

ventilatori centrifugo

varie



1	codice	601167	cod. costr.	FMOTEA482WRKZ
	descrizione	ventilatore centrifuga 230V tensione AC 50Hz H1 129mm L1 131mm D1 ø 75mm B1 103mm B2 44mm H2 57mm B3 61mm H3 61mm per microonde		

motori

motoriduttori

per microonde



1	codice	601969	cod. costr.	RMOTDA310WRZZ
	descrizione	motoriduttore ELENSYS tipo SM16 HK36MOHZ 3.5W 220-240V tensione AC 50-60Hz 10-12rpm albero ø 6,5x4,5mm per microonde ø 49mm		

condensatori e filtri antidisturbo

condensatori ad alta pressione



1	codice	365087	cod. costr.	RC-QZA264WRE0 RC-QZA391WRZZ
	descrizione	condensatore ad alta tensione per microonde 0.94µF tipo RC-QZA-391WRZZ 2300V 50/60Hz doppio attacco Faston maschio 6,3mm L 94mm H 38mm lar. 66mm dipendente di apparecchiatura alluminio conf. 1 pz		



1	codice	365088	cod. costr.	RC-QZA320WRZZ RC-QZA393WRZZ
	descrizione	condensatore ad alta tensione per microonde 1.07µF tipo RC-QZA-393WRZZ 2300V 50/60Hz doppio attacco Faston maschio 6,3mm L 98mm H 37mm lar. 65mm dipendente di apparecchiatura alluminio conf. 1 pz		

protezioni elettriche

fusibili



1	codice	358610	cod. costr.	QFS-CA026WRZZ
	descrizione	fusibile misura ø5x20mm 10A rapido nominale 250V conf. 10 pz		

varie



1	codice	358140	cod. costr.	QFS-CA017WRE0
	descrizione	fusibile grandezza ø6,3x32mmmm 017A		

portafusibili



1	codice	358834	cod. costr.	QFS-IA002WRE0 QFS-IA010WRZZ QFS-IA010WRZZ EHKE57
	descrizione	portafusibile per fusibile ø6,3x32mm fusibile adattabile ø6,3x32mm ø 15mm 0.8A nominale 5KV L 230mm attacco F6,3 con fusibile 0,8A rapido		



 <p>1</p>			
codice	358006	cod. costr.	QFS-IA004 QFS-IA004WRE0
descrizione	portafusibile per ø6,3x32mm nominale 5KV con fusibile 0,6A rapido		

ricambi per apparecchiature specifiche

per microonde

contenitori

parti esterne

 <p>1</p>			
codice	112544	cod. costr.	JBTN-A896WRM0
descrizione	pulsante a bottone lar. 60mm H 26mm argenteo		

parti interne

 <p>1</p>			
codice	691603	cod. costr.	PCUSUA404WRP0 PCUSUA404WRPO
descrizione	antivibrante L 8mm ø 14mm per tasti		

 <p>1</p>			
codice	694265	cod. costr.	FCOVPA032WRKZ FCOVPA036WRKZ Fcovpa032wrkz PCOVPA351WRF0
descrizione	cielo di forno L 326mm lar. 323mm H 40mm		

 <p>1</p>			
codice	112545	cod. costr.	JBTN-B263WRTZ
descrizione	set di tasti lar. 91mm H 35mm per microonde argenteo		

piastre in ceramica

 <p>1</p>			
codice	691039	cod. costr.	FGLSPA062WRE0
descrizione	piastra in ceramica L 335mm lar. 330mm per microonde		

porte

fogli

 <p>1</p>			
codice	691993	cod. costr.	PSHEPA428WRE0 PSHEPA520WRE0
descrizione	foglio L 288mm lar. 178mm autoadesivo per porta addentro		

molle a trazione

 <p>1</p>			
codice	691600	cod. costr.	MSPRCA097WRE0
descrizione	molla a trazione ø 9mm per camma di chiusura lungh. totale 47mm filo ø 1mm		

maniglie e volantini

maniglie

 <p>1</p>			
codice	691598	cod. costr.	FHNDMA011WRY0
descrizione	azionatore L 173mm lar. 15mm per maniglia tiro		

 <p>1</p>			
codice	691597	cod. costr.	JHNDMA039WRM0 JHNDMA039WRM0
descrizione	maniglia a ponte L 195mm H 51mm interasse di fissaggio 180mm per microonde maniglia M4		
ricambi per	691597		
	 codice	691598	cod. costr. FHNDMA-011WRY0
	azionatore L 173mm lar. 15mm per maniglia tiro		

pidi e tappi terminali

pidi ad innesto maschio



1

codice	700391	cod. costr.	GLEGPA074WRE0
descrizione	piede ø 20mm H 12mm incasso ø 7.5mm H tot. 18mm plastica conf. 1 pz		

molle

molle a trazione



1

codice	691600	cod. costr.	MSPRCA097WRE0
descrizione	molla a trazione ø 9mm per camma di chiusura lungh. totale 47mm filo ø 1mm		

materiale di consumo

protezioni elettriche

fusibili



1

codice	358610	cod. costr.	QFS-CA026WRZZ
descrizione	fusibile misura ø5x20mm 10A rapido nominale 250V conf. 10 pz		



1

codice	358140	cod. costr.	QFS-CA017WRE0
descrizione	fusibile grandezza ø6,3x32mmmm 017A		

portafusibili



1

codice	358006	cod. costr.	QFS-IA004 QFS-IA004WRE0
descrizione	portafusibile per ø6,3x32mm nominale 5KV con fusibile 0,6A rapido		

C

condensatori ad alta pressione	6
condensatori e filtri antidisturbo	6

F

fusibili	8
----------	---

I

interruttori e pulsanti	3
-------------------------	---

L

lampade	3
lampade per microonde	3

M

magnetron	3
materiale di consumo	8
microinterruttori	3
motori	6

P

protezioni elettriche	6,8
-----------------------	-----

S

sonde	4
-------	---

T

termostati	3
termostati a contatto	3,3
trasformatori	4

V

ventilatori	6
ventilatori centrifugo	6