



COMPONENTI PER GAS



COMPONENTI ELETTRICI



COMPONENTI PER ACQUA



COMPONENTI MECCANICI



UTENSILI

Ricambi adatti a

POLYDOR

Per la gamma completa sempre aggiornata visitate il nostro internet shop



Catalogo dei produttori

Per ciascun produttore, le parti di ricambio e gli accessori sono elencati in modo chiaro

- ✓ Assortimento completo e tutti i dati degli apparecchi sempre aggiornati nel Internetshop GEV
- ✓ Indice alfabetico alla fine del catalogo

Internetshop GEV Fast ricambi

www.fastricambi.it



- 🔍 Segna articolo come preferito
- 🔍 Procedi al log-in inserendo l'indirizzo mail e la password
- 🔍 Ordine Comfort – carica nel carrello una lista di articoli
- 🔍 Cerca ricambi in Cercafacile senza bisogno del log-in



resistenze

resistenze radianti

1



codice	415112	cod. costr.	202130
			600W m. Ceranscheibe GL-Serie
descrizione	resistenza infrarossi L 150mm lar. 135mm 600W 230V H 40mm con vetro		
ricambi per	415112		
	codice	691733	cod. costr.
			202010
	piano vetroceramica L 146mm lar. 125mm		

1



codice	416015	cod. costr.	202120
descrizione	resistenza radiante squadrata 600W 230V L 150mm lar. 135mm raccordi 2 tipo collegam. cavo		
accessori per	416015		
	codice	691733	cod. costr.
			202010
	piano vetroceramica L 146mm lar. 125mm		

interruttori e pulsanti

interruttori/pulsanti basculanti

19x13mm

1



codice	301066	cod. costr.	206440
descrizione	interruttore basculante dimensioni di montaggio 19x13mm nero 2NO 250V 6A 0-I attacco Faston maschio 4,8mm temperatura ambiente max. 85°C protezione IP40		
accessori per	301066		
	codice	301064	cod. costr.
			—
	copritasto per pulsante dimensione esterna 23,4x17,4mm dimensione interna 19x13mm H 7.5mm trasparente dimensioni di montaggiomm		

commutatori a camme

4 posizioni

1



codice	300023	cod. costr.	202170
descrizione	commutatore a camme 4 posizioni di comando 1NO/2CO frequenza delle interruzioni 0-1-2-3 16A alb. ø 6x4,6mm alb. L 23mm attacco a vite 4 posizioni ceramica		

lampade

lampade spia

lampade spia 2 pezzi (gemma più lampada)

lampade spia per attacco tipo SRZ / SDK / SDY / SFK

1



codice	359430	cod. costr.	201081
descrizione	lampada spia 230V trasparente attacco cavo 400mm		
accessori per	359430		
	codice	359260	cod. costr.
			—
	gemma portalamпада dimensioni di montaggio ø12mm giallo rotondo conf. 1 pz		

motori

motoriduttori

per grill gyros

1



codice	500504	cod. costr.	201530 201580
descrizione	motoriduttore POLYDOR tipo 28/1,5 230V 50Hz albero ø 20mm L 200mm lar. 113mm H 135mm		



1

codice	500500	cod. costr.	201530 201570
descrizione	motoriduttore POLYDOR tipo 850/1,5 230V 50Hz 1.5rpm albero ø 10mm L 120mm lar. 130mm H 100mm per grill gyros		



1

codice	501448	cod. costr.	201575
descrizione	motoriduttore POLYDOR tipo 850/1,5 230V 50Hz 1.5rpm albero ø 10mm L 120mm lar. 130mm H 100mm per grill gyros		



1

codice	500509	cod. costr.	201550 201580 Schukostecker
descrizione	motoriduttore POLYDOR tipo Maxi 2,0 U 230V 50Hz albero ø 20mm L 200mm lar. 130mm H 110mm per grill gyros		

rubinetti del gas

MADEC (MP)

con uscita per tubo



1

codice	109516	cod. costr.	202610	
descrizione	rubinetto del gas tipo 6H 500-008 gas liquido entrata gas flangia del tubo ø16mm by-pass ø 0.6mm uscita gas M12x1 (tubo ø 8mm) attacco per termocoppia M8x1 fissaggio frontale M12x1 alb. ø 6x4,6mm alb. L 18/10mm parte piana inferiore			
ricambi per	109516			
	codice	100427	cod. costr.	—
	by-pass MADEC foro ø 0.7mm filetto M4,5x0,6			

ricambi per	109516			
	codice	101051	cod. costr.	—
	gruppo magnetico L 27mm D1 ø 12.5mm D2 ø 8.5mm adattabile a JUNKERS/EGA/MADEC/SABAF standard			
	codice	101234	cod. costr.	—
	ghiera F1: M8x1 F2: M15			
accessori per	109516			
	codice	101277	cod. costr.	—
	anello bicono int. ø 8mm conf. 1 pz			
	codice	101296	cod. costr.	—
	ghiera filetto M12x1 per tubi ø 8mm			
	codice	101299	cod. costr.	—
	dado filetto M12x1			



EGA

serie 30750

rubinetti del gas







1

codice	101473	cod. costr.	200207 202610	
descrizione	rubinetto del gas EGA tipo serie 30750 con uscita per tubo entrata gas M12x1 (tubo ø 8mm) attacco per termocoppia M8x1 alb. ø 6x4,6mm by-pass ø 0.5mm alb. L 22mm lunghezza alberino manopola 19mm fissaggio frontale M12x1 parte piana superiore			
ricambi per	101473			
	codice	101051	cod. costr.	—
	gruppo magnetico L 27mm D1 ø 12.5mm D2 ø 8.5mm adattabile a JUNKERS/EGA/MADEC/SABAF standard			
accessori per	101473			
	codice	110153	cod. costr.	202630
	manopola rubinetto del gas senza pos. pilota ø 50mm alb. ø 6x4,6mm parte piana sx bianco			



bruciatori principali

bruciatori in ceramica

 <p>1</p>			
codice	104275	cod. costr.	202510 202570
descrizione	bruciatore in ceramica L 147mm lar. 132mm misura interna 133x94mm sottile		
ricambi per	104275		
	codice	104276	cod. costr. 202590 & 202580
	piastra in ceramica L 134mm lar. 96mm H 13mm con corda a fibre ceramiche		
	codice	104278	cod. costr. 202580
	cordone di tenuta L 500mm lar. 10mm spessore 10mm fibre céramique		
accessori per	104275		
	codice	104277	cod. costr. 202540
	griglia per bruciatore L 150mm lar. 110mm sottile		

accessori

griglie per bruciatori

 <p>1</p>			
codice	104277	cod. costr.	202540
descrizione	griglia per bruciatore L 150mm lar. 110mm sottile		

strisce di tenuta

 <p>1</p>			
codice	104278	cod. costr.	202580
descrizione	cordone di tenuta L 500mm lar. 10mm spessore 10mm fibre céramique		

piastre in ceramica

 <p>1</p>			
codice	104276	cod. costr.	202590 & 202580
descrizione	piastra in ceramica L 134mm lar. 96mm H 13mm con corda a fibre ceramiche		

ugelli del gas

ugelli per bruciatori principali

ugelli del gas diversi

 <p>1</p>			
codice	102551	cod. costr.	202530 202550 s.Bemerkung
descrizione	ugello del gas filetto M12x1 CH 13 foro ø 0.65mm per bruciatore sottile		

 <p>1</p>			
codice	100969	cod. costr.	202550 FG/Doppelbrenner
descrizione	ugello del gas filetto M12x1 CH 13 foro ø 0.85mm gas liquido per doppio bruciatore		

 <p>1</p>			
codice	106998	cod. costr.	202520
descrizione	ugello del gas filetto M12x1 CH 19 foro ø 1.1mm gas naturale per doppio bruciatore		

ricambi per apparecchiature specifiche

per grill gyros

vetri



1

codice 691733 **cod. costr.** 202010

descrizione piano vetroceramica L 146mm lar. 125mm

manopole

manopole universali

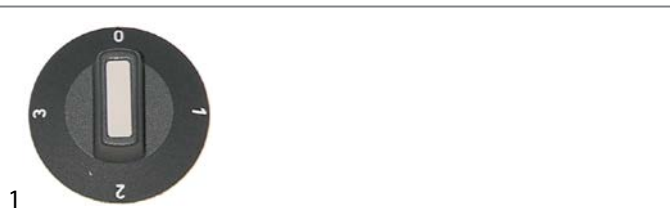

1

codice 110232 **cod. costr.** 202150

descrizione manopola interruttore 4 posizioni t. mass. °C ø 50mm alb. ø 6x4,6mm parte piana superiore nero

manopole personalizzate dal costruttore

POLYDOR



1

codice 110232 **cod. costr.** 202150

descrizione manopola interruttore 4 posizioni t. mass. °C ø 50mm alb. ø 6x4,6mm parte piana superiore nero



1

codice 110153 **cod. costr.** 202630

descrizione manopola rubinetto del gas senza pos. pilota ø 50mm alb. ø 6x4,6mm parte piana sx bianco

B

bruciatori in ceramica	5
bruciatori principali	5

C

commutatori a camme	3
---------------------	---

I

interruttori e pulsanti	3
interruttori/pulsanti basculanti	3

L

lampade	3
lampade spia	3

M

motori	3
--------	---

R

resistenze	3
resistenze radianti	3
rubinetti del gas	4

U

ugelli del gas	5
----------------	---