



COMPONENTI PER GAS



COMPONENTI ELETTRICI



COMPONENTI PER ACQUA



COMPONENTI MECCANICI



UTENSILI

Ricambi adatti a

JÜNGER

Per la gamma completa sempre aggiornata visitate il nostro internet shop



Catalogo dei produttori

Per ciascun produttore, le parti di ricambio e gli accessori sono elencati in modo chiaro

- ✓ Assortimento completo e tutti i dati degli apparecchi sempre aggiornati nel Internetshop GEV
- ✓ Indice alfabetico alla fine del catalogo

Internetshop GEV Fast ricambi

www.fastricambi.it



- 🔍 Segna articolo come preferito
- 🔍 Procedi al log-in inserendo l'indirizzo mail e la password
- 🔍 Ordine Comfort – carica nel carrello una lista di articoli
- 🔍 Cerca ricambi in Cercafacile senza bisogno del log-in

resistenze

resistenze per friggitrici

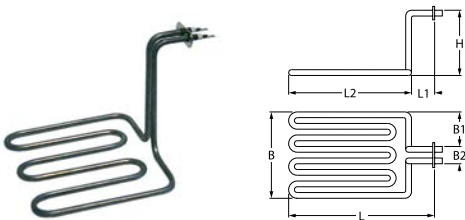

1

| | | | |
|---------------------|---|--------------------|--------|
| codice | 415342 | cod. costr. | 445258 |
| descrizione | resistenza 2000W 230V Nr. spirali 1 L 213mm lar. 202mm H 155mm L1 38mm L2 175mm B1 85mm B2 26mm lunghezza della flangia 50mm larghezza della flangia 22mm int. dei fori 40mm spire 3 attacco Faston maschio 6,3mm fori ø 4mm flangia rettangolare | | |
| Per modelli: | 258 | | |

resistenze per grill per hot dog



1

| | | | |
|---------------------|---|--------------------|--------|
| codice | 415754 | cod. costr. | 420000 |
| descrizione | resistenza 600W 230V L 138mm lar. 134mm H 29mm tubo ø 6.5mm attacco cavo lunghezza terminali 45mm lunghezza del cavo 300mm resistenza a secco flangia rettangolare Nr. spirali 1 int. dei fori 51mm lunghezza della flangia 60mm larghezza della flangia 22mm filetto di fissaggio M4 | | |
| Per modelli: | 250, 252, 253, 254 | | |

resistenze per griglie



1

| | | | |
|---------------------|--|--------------------|--------|
| codice | 415343 | cod. costr. | 421000 |
| descrizione | resistenza 1500W 230V L 300mm lar. 285mm H 30mm Nr. spirali 1 int. dei fori 305mm spire 3 filetto di fissaggio 1/8" lunghezza del cavo 280mm wurstel grill resistenza a secco lunghezza piastrina 26mm larghezza piastrina 24mm fissabile con viti lunghezza terminali 42mm tubo ø 6.3mm | | |
| Per modelli: | 271, 272 | | |

regolatori di energia

DIAMOND



1

| | | | |
|---------------------|--|--------------------|--------|
| codice | 380032 | cod. costr. | 423100 |
| descrizione | regolatore di energia 230V 13.5A senso di rotazione dx alb. ø 6x4,6mm alb. L 23mm filetto di fissaggio M4 cod. prod. 45ER104C1 | | |
| Per modelli: | 271, 272, 273, 274, 276 | | |

accessori

manopole



1

| | | | |
|---------------------|---|--------------------|--------|
| codice | 110238 | cod. costr. | 423120 |
| descrizione | manopola reg. di energia 1-10 t. mass. °C °C ø 50mm alb. ø 6x4,6mm parte piana superiore nero | | |
| Per modelli: | 271, 272, 273, 274, 276 | | |

termostati

termostati di regolazione e di sicurezza

EGO

termostati di sicurezza

Serie 55.13_



1

| | | | |
|---|---|--------------------|--------------------|
| codice | 375115 | cod. costr. | 422000 |
| descrizione | termostato di sicurezza temp. intervento 145°C 1 poli 1NO 16A bulbo ø 6mm bulbo L 73mm lungh. capillare 830mm isolante sul capillaremm premistoppa bulbo inox | | |
| accessori per | 375115 | | |
|  | codice | 551083 | cod. costr. |
| | tappo termostato di sicurezza filetto M8x1 | | |



termostati di regolazione con interruttore

serie 55.10/19_



codice 375473 **cod. costr.** 422100

descrizione termostato t. mass. 110°C campo di lavoro 37-110°C 1 poli 1NO 16A bulbo ø 6mm bulbo L 129mm lungh. capillare 570mm isolante sul capillaremm premistoppa alb. ø 6x4,6mm alb. L 23mm posizione alberino superiore angolo di rotazione 270° interruttore 2NO

RATHGEBER

termostati di regolazione con interruttore



codice 375931 **cod. costr.** 422100
422111

descrizione termostato t. mass. 110°C campo di lavoro 30-110°C 1 poli 1NC 16A bulbo ø 6mm bulbo L 140mm lungh. capillare 860mm isolante sul capillare 65mm alb. ø 6x4,6mm alb. L 26.5mm interruttore 2 poli

Per modelli: 250, 252, 253, 254

varie

termostati di sicurezza



codice 375932 **cod. costr.** 422200
422211

descrizione termostato di sicurezza temp. intervento 146°C campo di lavoro°C 1 poli 1NCA bulbo ø 6mm bulbo L 86mm lungh. capillare 850mm isolante sul capillare 50mm premistoppa alb. ømm bulbo inox raccordo M10x1

Per modelli: 250, 252, 253, 254, 258

lampade

lampade spia

lampade spia complete

ø10mm

con attacco a innesto



codice 359140 **cod. costr.** 426000

descrizione lampada spia ø 10mm giallo 230V attacco Faston maschio 6,3mm conf. 1 pz

Per modelli: 271, 272, 273, 274, 276

varie



codice 359018 **cod. costr.** 426000

descrizione lampada spia

rubinetti del gas

MADEC (MP)

con uscita portaugello



codice 101073 **cod. costr.** 431200

descrizione rubinetto del gas MADEC con uscita ugello (senza ugello) entrata gas M12x1 (tubo ø 8mm) ugello esterno ømm ugello interno ømm by-pass ø 0.35mm attacco di tubo miscelazione M17x1 attacco per termocoppia M8x1 fissaggio frontale M12x1 alb. ø 8x5mm alb. L 23/13,5mm parte piana dx uscita gas M17x1

Per modelli: 260, 269, 270

ricambi per 101073



codice 100936 **cod. costr.** —
alberino per rubinetti del gas alb. ø 5x8mm MADEC



codice 101051 **cod. costr.** 431440
gruppo magnetico L 27mm D1 ø 12.5mm D2 ø 8.5mm adattabile a JUNKERS/EGA/MADEC/SABAF standard



codice 101234 **cod. costr.** —
ghiera F1: M8x1 F2: M15

accessori per 101073







codice 100927 **cod. costr.** —
molla a torsione L 2,8-8,0mm per ugello interno ø 3mm foro ømm









codice 101277 **cod. costr.** —
anello bicono int. ø 8mm conf. 1 pz

Tabella continua alla prossima pagina





| | | | | |
|---|--|--------|-------------|--------|
| accessori per | 101073 | | | |
|  | codice | 101296 | cod. costr. | — |
| | ghiera filetto M12x1 per tubi ø 8mm | | | |
|  | codice | 101299 | cod. costr. | — |
| | dado filetto M12x1 | | | |
|  | codice | 101400 | cod. costr. | 431430 |
| | tubo miscelazione d'aria filetto M17x1 adattabile a L350, L700 | | | |
|  | codice | 110148 | cod. costr. | 431220 |
| | manopola rubinetto del gas senza pos. pilota ø 50mm alb. ø 8x5mm parte piana sx nero | | | |
|  | codice | 110150 | cod. costr. | — |
| | manopola rubinetto del gas senza pos. pilota t. mass. °C ø 50mm alb. ø 8x5,5mm parte piana dx bianco | | | |

| | | | | |
|---|--|--------------------|-------------|--------|
|  | 1 | | | |
| codice | 101193 | cod. costr. | 431310 | |
| descrizione | rubinetto del gas MADEC con uscita ugello (senza ugello) entrata gas M12x1 (tubo ø 8mm) ugello esterno ømm ugello interno ømm by-pass ø 0.35mm attacco di tubo miscelazione M17x1 attacco per termocoppia M8x1 fissaggio frontale M12x1 alb. ø 8x5mm alb. L 23/13,5mm parte piana sx | | | |
| Per modelli: | 280000, 282000, 285000, 286000 | | | |
| ricambi per | 101193 | | | |
|  | codice | 100360 | cod. costr. | — |
| | by-pass MADEC foro ø 0.35mm filetto M4,5x0,6 lungh. totale 13mm | | | |
|  | codice | 101051 | cod. costr. | 431440 |
| | gruppo magnetico L 27mm D1 ø 12.5mm D2 ø 8.5mm adattabile a JUNKERS/EGA/MADEC/SABAF standard | | | |
|  | codice | 101234 | cod. costr. | — |
| | ghiera F1: M8x1 F2: M15 | | | |
| accessori per | 101193 | | | |
|  | codice | 100936 | cod. costr. | — |
| | alberino per rubinetti del gas alb. ø 5x8mm MADEC | | | |
|  | codice | 101277 | cod. costr. | — |
| | anello bicono int. ø 8mm conf. 1 pz | | | |
|  | codice | 101296 | cod. costr. | — |
| | ghiera filetto M12x1 per tubi ø 8mm | | | |
|  | codice | 101299 | cod. costr. | — |
| | dado filetto M12x1 | | | |
|  | codice | 101400 | cod. costr. | 431430 |
| | tubo miscelazione d'aria filetto M17x1 adattabile a L350, L700 | | | |
|  | codice | 110150 | cod. costr. | — |
| | manopola rubinetto del gas senza pos. pilota t. mass. °C ø 50mm alb. ø 8x5,5mm parte piana dx bianco | | | |

| | | | | |
|---|--|--------------------|-------------|--------|
|  | 1 | | | |
| codice | 101194 | cod. costr. | 431110 | |
| descrizione | rubinetto del gas MADEC con uscita ugello (senza ugello) entrata gas M12x1 (tubo ø 8mm) ugello esterno ømm ugello interno ømm by-pass ø 0.35mm attacco di tubo miscelazione M17x1 attacco per termocoppia M8x1 fissaggio frontale M12x1 alb. ø 8x6mm alb. L 17/9mm parte piana superiore e inferiore | | | |
| Per modelli: | 251, 255, 256, 257 | | | |
| ricambi per | 101194 | | | |
|  | codice | 100360 | cod. costr. | — |
| | by-pass MADEC foro ø 0.35mm filetto M4,5x0,6 lungh. totale 13mm | | | |
|  | codice | 101051 | cod. costr. | 431440 |
| | gruppo magnetico L 27mm D1 ø 12.5mm D2 ø 8.5mm adattabile a JUNKERS/EGA/MADEC/SABAF standard | | | |
|  | codice | 101234 | cod. costr. | — |
| | ghiera F1: M8x1 F2: M15 | | | |
| accessori per | 101194 | | | |
|  | codice | 101277 | cod. costr. | — |
| | anello bicono int. ø 8mm conf. 1 pz | | | |
|  | codice | 101296 | cod. costr. | — |
| | ghiera filetto M12x1 per tubi ø 8mm | | | |
|  | codice | 101299 | cod. costr. | — |
| | dado filetto M12x1 | | | |
|  | codice | 101400 | cod. costr. | 431430 |
| | tubo miscelazione d'aria filetto M17x1 adattabile a L350, L700 | | | |

accensioni e termocoppie

elettrodi

| | | | | |
|---|---|--------------------|-------------|---|
|  | 1 | | | |
| codice | 100743 | cod. costr. | 401120 | |
| descrizione | candela accensione D1 ø 6mm L1 21mm LC1 18mm LC2 8mm LC3 19mm attacco F 2,8x0,8mm M10x1 | | | |
| Per modelli: | 260, 269, 270 | | | |
| accessori per | 100743 | | | |
|  | codice | 101860 | cod. costr. | — |
| | dado filetto M10x1 H 4mm CH 14 ottone cromato conf. 1 pz | | | |



accenditori piezo-elettrici

diametro di montaggio 22mm



| | | | |
|---------------------|---|--------------------|--------|
| codice | 100005 | cod. costr. | 401000 |
| descrizione | accenditore piezo-elettrico corpo plastica premente incasso ø 22mm attacco ø2,4mm lunghezza del cavommt SIT | | |
| Per modelli: | 260, 269, 270 | | |

termocoppie

termocoppie filettate

termocoppie filettate standard

con filetto M8x1

SIT

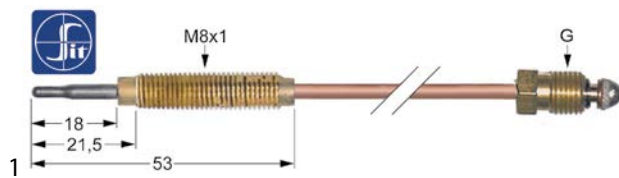

| | | | |
|---|---|--------------------|--------------------|
| codice | 107628 | cod. costr. | 431410 |
| descrizione | termocoppia SIT M8x1 L 320mm M8x1 | | |
| Per modelli: | 251, 255, 256, 257, 260, 269, 270, 280000, 282000, 285000, 286000 | | |
| accessori per | 107628 | | |
|  | codice | 102067 | cod. costr. |
| | dado filetto M8x1 H 3mm ottone conf. 1 pz tipo SEF 1 | | |

bruciatori principali

bruciatori piano cottura

accessori

miscelatori d'aria



| | | | |
|---------------------|--|--------------------|--------|
| codice | 101400 | cod. costr. | 431430 |
| descrizione | tubo miscelazione d'aria filetto M17x1 adattabile a L350, L700 | | |
| Per modelli: | 260, 269, 270, 280000, 282000, 285000, 286000 | | |

Bruciatori tubolari

Bruciatori tubolari



| | | | |
|---------------------|--|--------------------|--------|
| codice | 104220 | cod. costr. | 433280 |
| descrizione | bruciatore a barra a 3 file L 425mm lar. 110mm ø 20mm Hmm bistercheria con griglia | | |
| Per modelli: | 280000, 285000, 286000 | | |



| | | | |
|---------------------|--|--------------------|--------|
| codice | 104218 | cod. costr. | 433282 |
| descrizione | bruciatore a barra a 3 file L 440mm lar. 185mm ø 20mm Hmm bistercheria con griglia | | |
| Per modelli: | 282000 | | |

bruciatori ad anello



| | | | |
|---------------------|---|--------------------|--------|
| codice | 104222 | cod. costr. | 433270 |
| descrizione | bruciatore ad anello L 290mm lar. 180mm | | |
| Per modelli: | 269, 270 | | |



materiali ausiliari gas

regolatori di pressione

Pressione standard secondo paese:

Germania 50mbar

Francia 37mbar

Italia 30mbar

Spagna 37/50mbar

Regno Unito 20mbar



| | | | |
|---------------------|---|--------------------|--------|
| codice | 250005 | cod. costr. | 402110 |
| descrizione | regolatore di pressione gas EN61 attacco KLF - 1/4" a sinistra 50mbar/1,5kg/h paesi DE pressione di entrata fino a 16bar propano/butano CE 0085 | | |
| descrizione | regolatore di bassa pressione tipo EN61-DS - 50mbar, 1,5kg/h con dispositivo di protezione contro le sovrappressioni per installazioni industriali all'aperto entrata bombola piccola (3/8" sx), uscita 1/4" sx con cono interno | | |
| Per modelli: | 260, 269, 270, 280000, 282000 | | |

tubi flessibili per gas

DIN 4815 con certificato DVGW



| | | | |
|---------------------|--|--------------------|--------|
| codice | 250004 | cod. costr. | 403120 |
| descrizione | tubo gas flessibile DIN 4815 gomma con rivestimento tessile L 400mm 1/4" sx - tubo ø 12mm temp. massima fino a -30°C conduttura flessibile a pressione media | | |
| Per modelli: | 285000, 286000 | | |

ricambi per apparecchiature specifiche

per grill per hot dog

coperchi



| | | | |
|---------------------|---|--------------------|--------|
| codice | 697927 | cod. costr. | 414000 |
| descrizione | fermaglio per coperchio L 35mm lar. 20mm spessore 0.6mm | | |
| Per modelli: | 250, 251, 252, 253, 254, 255, 256, 257, 258 | | |

manopole

manopole universali



| | | | |
|---------------------|--|--------------------|--------|
| codice | 110238 | cod. costr. | 423120 |
| descrizione | manopola reg. di energia 1-10 t. mass. °C°C ø 50mm alb. ø 6x4,6mm parte piana superiore nero | | |
| Per modelli: | 271, 272, 273, 274, 276 | | |



| | | | |
|---------------------|---|--------------------|--------|
| codice | 110119 | cod. costr. | 422120 |
| descrizione | manopola termostato t. mass. 110°C ø 50mm alb. ø 6x4,6mm parte piana superiore nero campo di lavoro 30-110°C angolo di rotazione 270° | | |
| Per modelli: | 250, 252, 253, 254 | | |

| | | | | | |
|----------------------|--------|---------------|--------------------------------|--------------------|---|
| accessori per | 110119 | codice | 110135 | cod. costr. | — |
| | | | rosetta manopola fino a ø 52mm | | |

manopole personalizzate dal costruttore

JÜNGER





| | | | |
|---------------------|--|--------------------|--------|
| codice | 110238 | cod. costr. | 423120 |
| descrizione | manopola reg. di energia 1-10 t. mass. °C°C ø 50mm alb. ø 6x4,6mm parte piana superiore nero | | |
| Per modelli: | 271, 272, 273, 274, 276 | | |



| | | | |
|---------------------|--|--------------------|--------|
| codice | 110148 | cod. costr. | 431220 |
| descrizione | manopola rubinetto del gas senza pos. pilota ø 50mm alb. ø 8x5mm parte piana sx nero | | |
| Per modelli: | 260, 269, 270 | | |



| | | | |
|---|---|--------------------|--------|
|  | | | |
| 1 | | | |
| codice | 110149 | cod. costr. | 431320 |
| descrizione | manopola rubinetto del gas senza pos. pilota t. mass.°C campo di lavoro°C ø 50mm alb. ø 6x4,6mm parte piana dx nero | | |
| Per modelli: | 280000, 282000, 285000, 286000 | | |

| | | | |
|---|---|--------------------|--------|
|  | | | |
| 1 | | | |
| codice | 110119 | cod. costr. | 422120 |
| descrizione | manopola termostato t. mass. 110°C ø 50mm alb. ø 6x4,6mm parte piana superiore nero campo di lavoro 30-110°C angolo di rotazione 270° | | |
| Per modelli: | 250, 252, 253, 254 | | |
| accessori per | 110119 | | |
| |  | codice | 110135 |
| | cod. costr. — | | |
| | rosetta manopola fino a ø 52mm | | |

varie

| | | | |
|--|--|--------------------|--------|
|  | | | |
| 1 | | | |
| codice | 111409 | cod. costr. | 417000 |
| descrizione | maniglia L 51mm lar. 89mm con kit fissaggio conf. 1 pz | | |
| Per modelli: | 250, 251, 252, 253, 254, 255, 256, 257, 258 | | |

maniglie e volantini

maniglie a fungo

| | | | |
|---|---|--------------------|--------|
|  | | | |
| 1 | | | |
| codice | 111408 | cod. costr. | 416000 |
| descrizione | maniglia per coperchi con vite filetto M5 maniglia ø 48mm L 28mm nero | | |
| Per modelli: | 250, 251, 252, 253, 254, 255, 256, 257, 258 | | |

A

accenditori piezo-elettrici 6

B

bruciatori ad anello 6

bruciatori piano cottura 6

bruciatori principali 6

Bruciatori tubolari 6

L

lampade 4

lampade spia 4

lampade spia complete 4

R

regolatori di energia 3

regolatori di pressione 7

resistenze 3

resistenze per friggitrice 3

resistenze per griglie 3

rubinetti del gas 4

T

termocoppie 6

termostati 3

termostati di sicurezza 3

tubi flessibili per gas 7