



COMPONENTI PER GAS



COMPONENTI ELETTRICI



COMPONENTI PER ACQUA



COMPONENTI MECCANICI



UTENSILI

Ricambi adatti a

FRYLAND

Per la gamma completa sempre aggiornata visitate il nostro internet shop



Catalogo dei produttori

Per ciascun produttore, le parti di ricambio e gli accessori sono elencati in modo chiaro

- ✓ Assortimento completo e tutti i dati degli apparecchi sempre aggiornati nel Internetshop GEV
- ✓ Indice alfabetico alla fine del catalogo

Internetshop GEV Fast ricambi

www.fastricambi.it



- 🔍 Segna articolo come preferito
- 🔍 Procedi al log-in inserendo l'indirizzo mail e la password
- 🔍 Ordine Comfort – carica nel carrello una lista di articoli
- 🔍 Cerca ricambi in Cercafacile senza bisogno del log-in



valvole e rubinetti termostatici

SIT

serie 710 Minisit

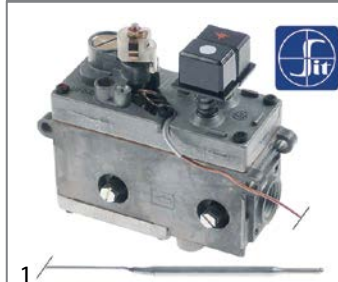

codice	101135	cod. costr.	03137
descrizione	termostato gas SIT tipo MINISIT 710 t. mass. 190°C 110-190°C entrata gas 1/2" uscita gas 3/8" attacco per termocoppia M9x1 collegamento pilota M10x1 bulbo ø 6mm bulbo L 102mm lungh. capillare 1050mm tipo di sensore tipo A3 pressostato non presente pressostatambar premistoppa		
Per modelli:	Lt15+15g-ce		
ricambi per	101135		
	codice	101053	cod. costr. —
	gruppo magnetico F1: M9x1 F2: M24x1 L 45mm ø 17mm adattabile a Minisit		
	codice	102118	cod. costr. —
	sonda 110-190°C bulbo ø 6mm bulbo L 102mm lungh. capillare 1050mm t. mass. 190°C friggitrice tipo di sensore tipo A3 adattabile a MINISIT 710		
accessori per	101135		
	codice	100809	cod. costr. —
	O.R. EPDM spessore 2mm int. ø 21mm conf. 1 pz		
	codice	100820	cod. costr. —
	bussola premistoppa M M14x1,5 F M10x0,75 bulbo ø max. 6.5mm CH 22		
	codice	100904	cod. costr. —
	vite di serraggio M10x1 per tubo ø 4mm conf. 1 pz		
	codice	100905	cod. costr. —
	vite di serraggio M10x1 per tubo ø 6mm conf. 1 pz		
	codice	101054	cod. costr. —
	gruppo magnetico F1: M10x1 F2: M24x1 L 45mm ø 17mm adattabile a Minisit		
	codice	101136	cod. costr. —
	accenditore piezo-elettrico adattabile a Minisit con mascherina ømm attacco F6,3x0,8		
	codice	101137	cod. costr. —
	mascherina senza accensione piezoelettrica		
	codice	101267	cod. costr. —
	riduzione F 3/8" M 1/2" L 21mm		
	codice	101268	cod. costr. —
	raccordo gas filetto 3/8" ad angolo con O.R. MINISIT 710		
	codice	101269	cod. costr. —
	raccordo gas filetto 1/2" ad angolo con O.R. MINISIT 710		
	codice	101270	cod. costr. —
	raccordo filettato F 3/8" M 3/8" L 28mm		

accessori per	101135		
	codice	101272	cod. costr. —
	raccordo filettato F 1/2" M 3/8" L 57mm		
	codice	101273	cod. costr. —
	anello bicono per tubo ø 12mm L 9.5mm ottone conf. 1 pz adattabile a universale		
	codice	101274	cod. costr. —
	anello bicono per tubo ø 16mm conf. 1 pz		
	codice	101275	cod. costr. —
	vite bicono filetto 1/2" per tubo ø 16mm conf. 1 pz		
	codice	101276	cod. costr. —
	vite bicono filetto 3/8" tubo ø 12mm conf. 1 pz		
	codice	110068	cod. costr. —
	manopola adattabile a Minisit ø 37mm		

accensioni e termocoppie

bruciatori pilota

SIT

serie 100



codice	107139	cod. costr.	03139
descrizione	bruciatore pilota SIT tipo serie 100 1-fiamma ugello ø 0.2mm attacco gasmm		
Per modelli:	Lt15+15g-ce		
ricambi per	107139		
	codice	100854	cod. costr. —
	supporto bruciatore pilota doppio		
	codice	100885	cod. costr. —
	bussola miscelazione d'aria per bruciatore pilota conf. 1 pz		
	codice	107160	cod. costr. —
	testina per pilota SIT 1-fiamma Hmm Lmm conf. 1 pz		
accessori per	107139		
	codice	100904	cod. costr. —
	vite di serraggio M10x1 per tubo ø 4mm conf. 1 pz		
	codice	100905	cod. costr. —
	vite di serraggio M10x1 per tubo ø 6mm conf. 1 pz		
	codice	100998	cod. costr. —
	parte inferiore del bruciatore pilota ugello ø 0.21mm adattabile a serie 100		
	codice	102110	cod. costr. —
	tubo gas accensione rame tubo ø 4mm spessore della parete 1mm L 3000mm		

Tabella continua alla prossima pagina





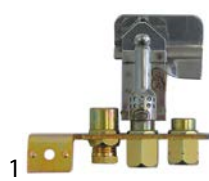

accessori per	107139		
	codice	102111	cod. costr. —
	tubo gas accensione rame tubo ø 6mm spessore della parete 1mm L 3000mm		

POLIDORO

bruciatori pilota



codice	100076	cod. costr.	03479
descrizione	bruciatore pilota POLIDORO 3-fiamme gas naturale indice 29.2 attacco gas 6mm		
Per modelli:	SC6FG		
ricambi per	100076		
	codice	100907	cod. costr. —
	raccordo filettato filetto M10x1 conf. 1 pz tipo SEF 1 ømm per termocoppia		
accessori per	100076		
	codice	100000	cod. costr. —
	ugello per bruciatore pilota POLIDORO gas liquido indice 22 foro ø 0.22mm conf. 1 pz		
	codice	100208	cod. costr. —
	ugello per bruciatore pilota POLIDORO gas liquido indice 20 foro ø 0.2mm conf. 1 pz		
	codice	100209	cod. costr. —
	ugello per bruciatore pilota POLIDORO gas naturale indice 40 foro ø 0.4mm conf. 1 pz		
	codice	100701	cod. costr. —
	candela accensione attacco M4 conf. 1 pz		
	codice	100906	cod. costr. —
	raccordo filettato filetto M10x1 per elettrodo accensione ottone conf. 1 pz CH 10		
	codice	100907	cod. costr. —
	raccordo filettato filetto M10x1 conf. 1 pz tipo SEF 1 ømm per termocoppia		
	codice	100908	cod. costr. —
	vite bicono filetto M10x1 per tubo ø 4mm conf. 1 pz		
	codice	100909	cod. costr. —
	vite bicono filetto M10x1 per tubo ø 6mm conf. 1 pz		
	codice	102110	cod. costr. —
	tubo gas accensione rame tubo ø 4mm spessore della parete 1mm L 3000mm		
	codice	102111	cod. costr. —
	tubo gas accensione rame tubo ø 6mm spessore della parete 1mm L 3000mm		
	codice	102508	cod. costr. —
	vite bicono filetto M10x1 per tubo ø 4mm conf. 5 pz		
	codice	102509	cod. costr. —
	vite bicono filetto M10x1 per tubo ø 6mm conf. 5 pz		
	codice	102699	cod. costr. —
	ugello per bruciatore pilota POLIDORO gas naturale indice 25.2 foro ø 2x0,25mm conf. 1 pz 2 fori		

accessori per	100076		
	codice	102795	cod. costr. —
	anello bicono per tubo ø 4mm conf. 1 pz		
	codice	102797	cod. costr. —
	anello bicono per tubo ø 6mm conf. 1 pz		
	codice	106703	cod. costr. —
	ugello per bruciatore pilota POLIDORO gas naturale indice 27.2 foro ø 2x0,27mm conf. 1 pz		
	codice	106704	cod. costr. —
	ugello per bruciatore pilota POLIDORO gas liquido indice 16.2 foro ø 2x0,16mm conf. 1 pz		
	codice	106763	cod. costr. —
	ugello per bruciatore pilota POLIDORO gas naturale indice 27.2A foro ø 2x0,27mm conf. 1 pz		
	codice	106859	cod. costr. —
	ugello per bruciatore pilota POLIDORO gas liquido indice 24 foro ø 0.24mm conf. 1 pz		

accenditori piezo-elettrici

varie





codice	107517	cod. costr.	03288
descrizione	accenditore piezo-elettrico adattabile a Minisit attacco F6,3x0,8 con mascherina ø 22mm		
ricambi per	107517		
	codice	107564	cod. costr. —
	accenditore piezo-elettrico corpo plastica premente attacco F6,3x0,8 ø 22mm		
accessori per	107517		
	codice	100025	cod. costr. —
	cavo di accensione lunghezza del cavo 600mm attacco ø4mm / F6,3mm		

cerniere

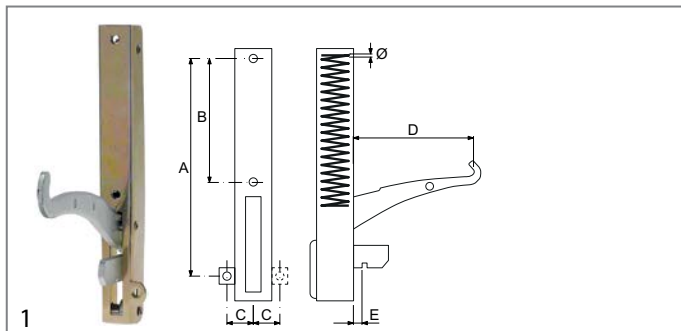
cerniere forno



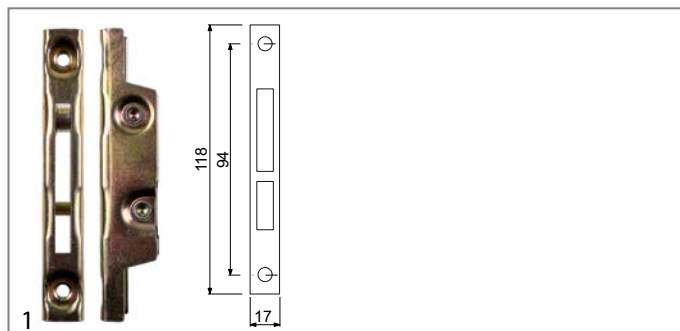

codice	700007	cod. costr.	03478s
descrizione	cerniera forno interasse di fissaggio 173mm interasse di fissaggio 2105mm fissaggio ganascia 14mm lunghezza leva 120mm distanza scanalatura 11mm spessore molla 3.5mm posiz. asole dx lunghezza molla 112mm lar. 25mm		
accessori per	700007		
	codice	700001	cod. costr. 03808c
	controsupporto L 118mm lar. 17mm interasse di fissaggio 94mm		
	codice	700006	cod. costr. 03478D
	cerniera forno interasse di fissaggio 173mm interasse di fissaggio 2105mm fissaggio ganascia 14mm lunghezza leva 120mm distanza scanalatura 11mm spessore molla 3.5mm posiz. asole sx lunghezza molla 112mm lar. 25mm		

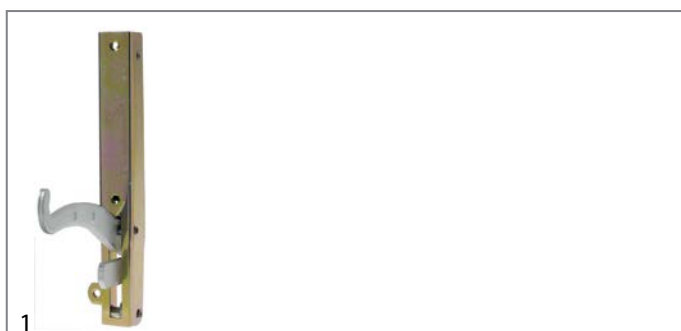

codice	700001	cod. costr.	03808c
descrizione	controsupporto L 118mm lar. 17mm interasse di fissaggio 94mm		



codice	700006	cod. costr.	03478D
descrizione	cerniera forno interasse di fissaggio 173mm interasse di fissaggio 2105mm fissaggio ganascia 14mm lunghezza leva 120mm distanza scanalatura 11mm spessore molla 3.5mm posiz. asole sx lunghezza molla 112mm lar. 25mm		
accessori per	700006		
	codice	700001	cod. costr. 03808c
	controsupporto L 118mm lar. 17mm interasse di fissaggio 94mm		
	codice	700007	cod. costr. 03478s
	cerniera forno interasse di fissaggio 173mm interasse di fissaggio 2105mm fissaggio ganascia 14mm lunghezza leva 120mm distanza scanalatura 11mm spessore molla 3.5mm posiz. asole dx lunghezza molla 112mm lar. 25mm		

A

accenditori piezo-elettrici 4

B

bruciatori pilota 3

C

cerniere forno 5

V

valvole e rubinetti termostatici 3