



COMPONENTI PER GAS



COMPONENTI ELETTRICI



COMPONENTI PER ACQUA



COMPONENTI MECCANICI



UTENSILI

Ricambi adatti a

DESCO

Per la gamma completa sempre aggiornata visitate il nostro internet shop



Catalogo dei produttori

Per ciascun produttore, le parti di ricambio e gli accessori sono elencati in modo chiaro

- ✓ **Assortimento completo e tutti i dati degli apparecchi sempre aggiornati nel Internetshop GEV**
- ✓ **Indice alfabetico alla fine del catalogo**

Internetshop GEV Fast ricambi

www.fastricambi.it



- 🔍 **Segna articolo come preferito**
- 🔍 **Procedi al log-in inserendo l'indirizzo mail e la password**
- 🔍 **Ordine Comfort – carica nel carrello una lista di articoli**
- 🔍 **Cerca ricambi in Cercafacile senza bisogno del log-in**

resistenze

resistenze per salamandre/tostapane

			
1			
codice	415450	cod. costr.	R_6002058-GI
descrizione	resistenza 650W 230V L 265mm lar. 55mm filetto M15x1 interasse di fissaggio 45mm lunghezza terminali 38mm tubo ø 10mm Nr. spirali 1 resistenza a secco fissaggio a 2 fori H 10mm		

resistenze radianti

a singolo circuito

			
1			
codice	490025	cod. costr.	860060
descrizione	resistenza radiante ø 200mm 1700W 230V Nr. spirali 1 regolazione di energia con segnalatore di temperatura con resistenza a spirale raccordi 2+2 tipo collegam. Faston maschio 6,3mm EGO		

piastre di cottura

quadrate e rettangolari

con bordo in acciaio inox

			
1			
codice	490056 ¹	cod. costr.	60209
descrizione	piastra elettrica dimensioni 300x300mm 3000W 230V con bordo inox attacco 4 morsetti a vite protettore presente quadrato		

¹con protettore

circolari

con bordo in acciaio inox

per domestico e industriale

			
1			
codice	490020	cod. costr.	60208
descrizione	piastra elettrica ø 220mm 2600W 230V attacco 4 morsetti a vite bordo da 8mm.		
accessori per	490020		
	codice	550796	cod. costr.
			—
	piastra di fissaggio per piastra ø220mm		

termostati

termostati di regolazione e di sicurezza

EGO

termostati di regolazione

serie 55.10/19_

			
1			
codice	390040	cod. costr.	60780
descrizione	termostato t. mass. 90°C campo di lavoro 30-90°C 1 poli 1CO 16A bulbo ø 6mm bulbo L 130mm lungh. capillare 2040mm isolante sul capillare 1940mm premistoppa alb. ø ø6x4,6mm alb. L 23mm posizione alberino superiore angolo di rotazione 270° materiale del bulbo inox		

termostati di sicurezza

serie 55.32_

			
1			
codice	375394	cod. costr.	60774
descrizione	termostato di sicurezza temp. intervento 135°C 3 poli 1CO/2NC 20A bulbo ø 6mm bulbo L 73mm lungh. capillare 1490mm isolante sul capillare 1350mm premistoppa M9x1 bulbo inox		

interruttori e pulsanti

pulsanti e interruttori a pressione

19x13mm



			
1			
codice	301054	cod. costr.	61286
descrizione	pulsante a pressione dimensioni di montaggio 19x13mm rosso 1NO 250V 16A attacco Faston maschio 6,3mm temperatura ambiente max. 105/55°C protezione IP65 con mascherina		



commutatori a camme

7 posizioni



codice	300025	cod. costr.	60452
descrizione	commutatore a camme 7 posizioni di comando 1NO/2CO frequenza delle interruzioni 0-1-2-3-4-5-6 16A alb. ø 6x4,6mm alb. L 23mm attacco a vite 7 posizioni ceramica		
accessori per	300025		
	codice	112172	cod. costr. —
	manopola universale ø 70mm nero senza adattatore/segnalino		
	codice	112213	cod. costr. —
	segnalino per manopola argenteo interruttore 7 posizioni t. mass. °C ø est. 63mm int. ø 45.5mm		
	codice	112311	cod. costr. —
	adattatore manopole alb. ø 6x4,6mm L 0mm con molla		

4 posizioni







codice	300210	cod. costr.	60773 EL0127
descrizione	commutatore a camme 4 posizioni di comando 4NO frequenza delle interruzioni 0-1-2-3 16A alb. ø 6x4,6mm alb. L 23mm attacco a vite ceramica		
accessori per	300210		
	codice	551456	cod. costr. —
	guarnizione per interruttore ø est. 14mm int. ø 2.5mm spessore 3.5mm bianco		

valvole e rubinetti termostatici

SIT

serie 630 Eurosit



codice	101696	cod. costr.	R_60249
descrizione	termostato gas tipo serie 630 Eurosit t. mass. 300°C 60-300°C entrata gas 3/8" uscita gas 3/8" attacco per termocoppia M9x1 collegamento pilota M10x1 bulbo ø 4mm bulbo L 72mm lungh. capillare 1050mm SIT		
ricambi per	101696		
	codice	101333	cod. costr. —
	tappo filetto 3/8" con O.R.		
accessori per	101696		
	codice	100904	cod. costr. —
	vite di serraggio M10x1 per tubo ø 4mm conf. 1 pz		
	codice	100905	cod. costr. —
	vite di serraggio M10x1 per tubo ø 6mm conf. 1 pz		
	codice	101273	cod. costr. —
	anello bicono per tubo ø 12mm L 9.5mm ottone conf. 1 pz adattabile a universale		
	codice	101276	cod. costr. —
	vite bicono filetto 3/8" tubo ø 12mm conf. 1 pz		



valvole del gas e centraline di accensione

valvole di regolazione gas

SIT

NOVASIT



1

codice	101956	cod. costr.	R_60309
descrizione	valvola per gas SIT serie Novasit 820 aliment. 230V 50Hz entrata gas 1/2" uscita gas 1/2" attacco per termocoppia M9x1 collegamento pilota M10x1 pressione di accensione 5-50mbar campo di pressione 5-50mbar collegamento per pressostato cieco cod. prod. 0.820.031		
ricambi per	101956		
	codice	101065	cod. costr. —
	gruppo magnetico con cavo L 44mm D1 ø 30mm D2 ø 20mm adattabile a NOVASIT		
	codice	101313	cod. costr. —
	bobina magnetica 230V 50Hz		
accessori per	101956		
	codice	100006	cod. costr. —
	accenditore piezo-elettrico adattabile a ELETTROSIT corpo plastica premente attacco ø2,4mm ø 14mm		
	codice	101305	cod. costr. —
	raccordo gas dritta 1/2" flangia 45x45mm ELETTROSIT/V4400/4600/4605 adattabile a SIT/HONEYWELL int. dei fori 36x36mm		
	codice	101306	cod. costr. —
	raccordo gas ad angolo flangia 45x45mm int. dei fori 36x36mm 1/2" ELETTROSIT/V4400/4600/4605 a vite con O.R. adattabile a SIT/HONEYWELL		
	codice	101307	cod. costr. —
	raccordo gas dritta flangia 45x45mm int. dei fori 36x36mm 3/4" ELETTROSIT/V4400/4600/4605 a vite con O.R. adattabile a SIT/HONEYWELL		
	codice	101308	cod. costr. —
	raccordo gas ad angolo flangia 45x45mm int. dei fori 36x36mm 3/4" ELETTROSIT/V4400/4600/4605 a vite con O.R. adattabile a SIT/HONEYWELL		
	codice	101312	cod. costr. —
	microinterruttore		
	codice	101314	cod. costr. —
	bobina magnetica 24V 50Hz		
	codice	101317	cod. costr. —
	spina con cavo L 1000mm adattabile a NOVASIT		
	codice	101318	cod. costr. —
	mascherina per bobina adattabile a NOVASIT		

accensioni e termocoppie













bruciatori pilota

SIT









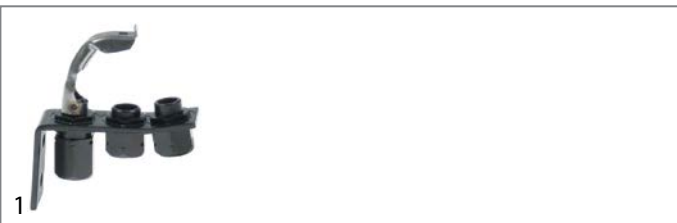





serie 140 - 145 -150



1

codice	107134	cod. costr.	R_60354
descrizione	bruciatore pilota SIT tipo serie 140 1-fiamma ugello ømm attacco gasm		
accessori per	107134		
	codice	100204	cod. costr. —
	ugello per bruciatore pilota SIT gas liquido indice 14 foro ø 0,18/0,20mm conf. 1 pz adattabile a serie 140		
	codice	100205	cod. costr. —
	ugello per bruciatore pilota SIT gas liquido indice 19 foro ø 0,23/0,26mm conf. 1 pz adattabile a SIT serie 150		
	codice	100206	cod. costr. —
	ugello per bruciatore pilota SIT gas naturale indice 36 foro ø 0,60/0,55mm conf. 1 pz adattabile a SIT serie 150		
	codice	100207	cod. costr. —
	ugello per bruciatore pilota SIT gas naturale indice 27 foro ø 0,40/0,38mm adattabile a SIT serie 140		
	codice	100216	cod. costr. —
	ugello per bruciatore pilota SIT gas naturale indice 38 foro ø 0,45mm conf. 1 pz adattabile a SIT serie 150		
	codice	100701	cod. costr. —
	candela accensione attacco M4 conf. 1 pz		
	codice	100897	cod. costr. —
	anello bicono per tubo ø 4mm conf. 1 pz per bruciatore pilota		
	codice	100898	cod. costr. —
	anello bicono per tubo ø 6mm conf. 1 pz per bruciatore pilota		
	codice	100906	cod. costr. —
	raccordo filettato filetto M10x1 per elettrodo accensione ottone conf. 1 pz CH 10		
	codice	100907	cod. costr. —
	raccordo filettato filetto M10x1 conf. 1 pz tipo SEF 1 ømm per termocoppia		
	codice	100908	cod. costr. —
	vite bicono filetto M10x1 per tubo ø 4mm conf. 1 pz		
	codice	100909	cod. costr. —
	vite bicono filetto M10x1 per tubo ø 6mm conf. 1 pz		



codice	107132	cod. costr.	111003
descrizione	bruciatore pilota SIT tipo serie 140 2-fiamme ugello \varnothing mm attacco gasmm		
accessori per	107132		
	codice	cod. costr.	—
	ugello per bruciatore pilota SIT gas liquido indice 14 foro \varnothing 0,18/0,20mm conf. 1 pz adattabile a serie 140		
	codice	cod. costr.	—
	ugello per bruciatore pilota SIT gas liquido indice 19 foro \varnothing 0,23/0,26mm conf. 1 pz adattabile a SIT serie 150		
	codice	cod. costr.	—
	ugello per bruciatore pilota SIT gas naturale indice 36 foro \varnothing 0,60/0,55mm conf. 1 pz adattabile a SIT serie 150		
	codice	cod. costr.	—
	ugello per bruciatore pilota SIT gas naturale indice 27 foro \varnothing 0,40/0,38mm adattabile a SIT serie 140		
	codice	cod. costr.	—
	ugello per bruciatore pilota SIT gas naturale indice 38 foro \varnothing 0,45mm conf. 1 pz adattabile a SIT serie 150		
	codice	cod. costr.	—
	candela accensione attacco M4 conf. 1 pz		
	codice	cod. costr.	—
	anello bicono per tubo \varnothing 4mm conf. 1 pz per bruciatore pilota		
	codice	cod. costr.	—
	anello bicono per tubo \varnothing 6mm conf. 1 pz per bruciatore pilota		
	codice	cod. costr.	—
	raccordo filettato filetto M10x1 per elettrodo accensione ottone conf. 1 pz CH 10		
	codice	cod. costr.	—
	raccordo filettato filetto M10x1 conf. 1 pz tipo SEF 1 \varnothing mm per termocoppia		
	codice	cod. costr.	—
	vite bicono filetto M10x1 per tubo \varnothing 4mm conf. 1 pz		
	codice	cod. costr.	—
	vite bicono filetto M10x1 per tubo \varnothing 6mm conf. 1 pz		
	codice	cod. costr.	—
	tubo gas accensione rame tubo \varnothing 4mm spessore della parete 1mm L 3000mm		
	codice	cod. costr.	—
	tubo gas accensione rame tubo \varnothing 6mm spessore della parete 1mm L 3000mm		

cavi di accensione

cavi confezionati





codice	100016	cod. costr.	R_110263
descrizione	cavo di accensione lunghezza del cavo 900mm attacco \varnothing 2,4mm / \varnothing 2,4mm		

accenditori piezo-elettrici

diametro di montaggio 18mm



codice	100009	cod. costr.	R_60829
descrizione	accenditore piezo-elettrico corpo plastica premente incasso \varnothing 18mm attacco \varnothing 2,4mm dimensioni frontali 26mm M18x1,5		

accessori per	100009		
	codice	cod. costr.	—
	mascherina per accensione piezoelettrica		
	codice	cod. costr.	—
	mascherina per accensione piezoelettrica int. \varnothing 22mm \varnothing est. 35mm H 25mm		
	codice	cod. costr.	—
	mascherina per accensione piezoelettrica int. \varnothing 21mm \varnothing est. 36mm		

termocoppie

termocoppie lisce

termocoppie lisce standard

con corpo \varnothing 6(6,5)mm

termocoppie SIT

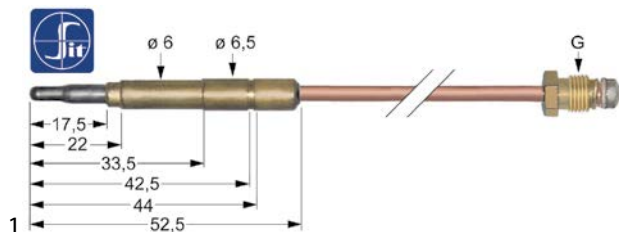

codice	107614	cod. costr.	R_61061
descrizione	termocoppia SIT M9x1 L 1500mm attacco ad innesto \varnothing 6,0(6,5)mm		

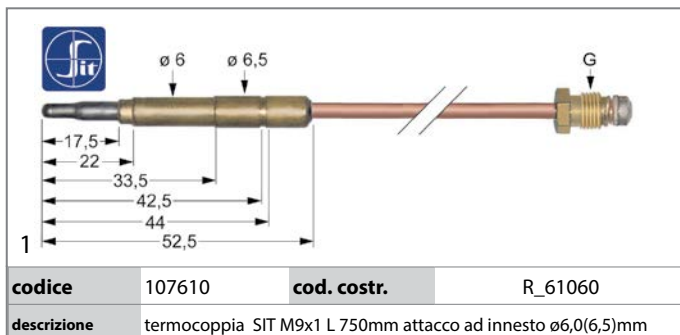

codice	107610	cod. costr.	R_61060
descrizione	termocoppia SIT M9x1 L 750mm attacco ad innesto $\varnothing 6,0(6,5)$ mm		

termocoppie lisce interrotte

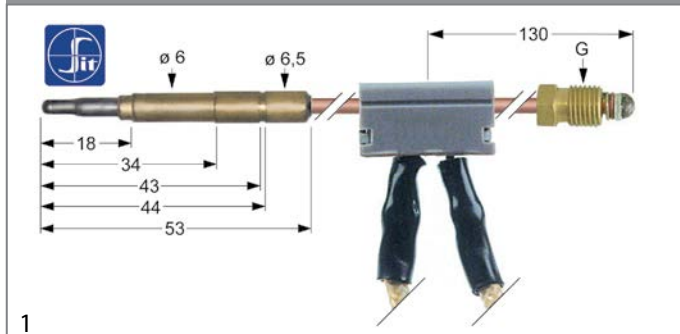

codice	107863	cod. costr.	R_62398
descrizione	termocoppia SIT con giunto interrotto M9x1 L 1000mm attacco ad innesto $\varnothing 6,0(6,5)$ mm		

accessori

viti

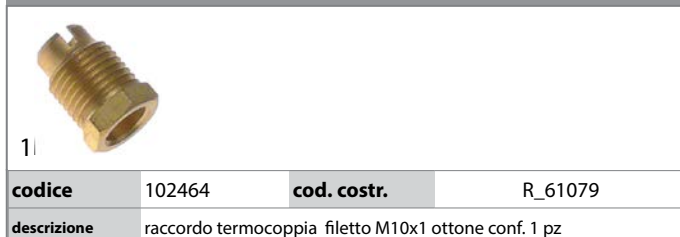

codice	102464	cod. costr.	R_61079
descrizione	raccordo termocoppia filetto M10x1 ottone conf. 1 pz		

cesti

cesti per cuocipasta

DESCO



codice	970568	cod. costr.	CD044
descrizione	cestello per cuocipasta L1 165mm B1 304mm H1 204mm misura GN 1/3 acciaio inox		



codice	970569	cod. costr.	CD045
descrizione	cestello per cuocipasta L1 242mm B1 304mm H1 204mm misura GN 1/2 acciaio inox		



codice	970567	cod. costr.	CD043
descrizione	cestello per cuocipasta L1 304mm B1 165mm H1 204mm misura GN 1/3 acciaio inox		



codice	970570	cod. costr.	CD046
descrizione	cestello per cuocipasta L1 480mm B1 305mm H1 180mm misura GN 1/1 acciaio inox		

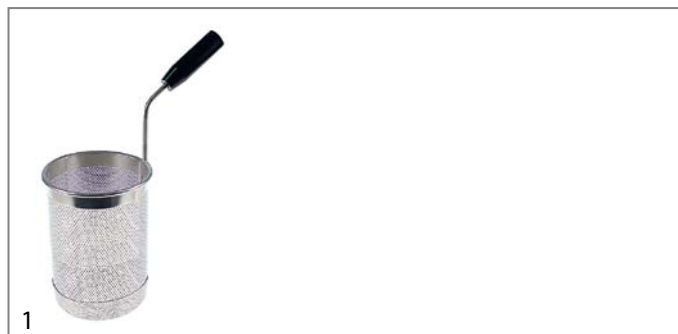

codice	970429	cod. costr.	CD047
descrizione	cestello per cuocipasta $\varnothing 145$ mm H1 205mm H3 370mm acciaio inox		

		
1		
codice	970571	cod. costr. CD048
descrizione	griglia ripiano L 475mm lar. 250mm H 110mm acciaio inox adattabile a cuocipasta	

guarnizioni

guarnizioni termiche

guarnizioni per facciata con agganci

		
1		
codice	692546 ¹	cod. costr. 60045
descrizione	guarnizione per porta L 255mm lar. 630mm a 3 lati lato lungo aperto con 6 ganci di fissaggio	

¹3 lati, lato lungo aperto

evaporatori

per frigoriferi



personalizzati dal costruttore



		
1		
codice	750450	cod. costr. R_19619
descrizione	evaporatore L 490mm H 70mm lar. 395mm per tavoli refrigerato adattabile a ILSA	

valvole e raccordi per vasca

rubinetti di arresto

universali

			
1			
codice	540935	cod. costr.	110120
descrizione	valvola di arresto attacco tubo ø 10mm lunghezza 110mm asse 7x7mm		
accessori per	540935		
	codice	110287	cod. costr. —
	manopola acqua t. mass.°C campo di lavoro°C ø 50mm alb. ø 7x7mm parte piana nero		

			
1			
codice	541982	cod. costr.	115120
descrizione	valvola d'arresto attacco 1/2" F - 1/2" F filetto di fissaggio M27x1,5		
accessori per	541982		
	codice	547713	cod. costr. —
	manopola a croce sede albero ø 8mm marcatura blu tipo F adattabile a MONOLITH		

A	
accenditori piezo-elettrici	6
B	
bruciatori pilota	5
C	
cavi di accensione	6
commutatori a camme	4
E	
evaporatori	8
G	
guarnizioni per facciata con agganci	8
guarnizioni termiche	8
I	
interruttori e pulsanti	3
P	
piastre di cottura	3
pulsanti e interruttori a pressione	3
R	
resistenze	3
resistenze per salamandre/tostapane	3
resistenze radianti	3
rubinetti di arresto	8
T	
termocoppie	6
termostati	3
termostati di regolazione	3
termostati di sicurezza	3
V	
valvole di regolazione gas	5
valvole e raccordi per vasca	8
valvole e rubinetti termostatici	4