



COMPONENTI PER GAS



COMPONENTI ELETTRICI



COMPONENTI PER ACQUA



COMPONENTI MECCANICI



UTENSILI

Ricambi adatti a

DELRUE

Per la gamma completa sempre aggiornata visitate il nostro internet shop



Catalogo dei produttori

Per ciascun produttore, le parti di ricambio e gli accessori sono elencati in modo chiaro

- ✓ **Assortimento completo e tutti i dati degli apparecchi sempre aggiornati nel Internetshop GEV**
- ✓ **Indice alfabetico alla fine del catalogo**

Internetshop GEV Fast ricambi

www.fastricambi.it



- 🔍 **Segna articolo come preferito**
- 🔍 **Procedi al log-in inserendo l'indirizzo mail e la password**
- 🔍 **Ordine Comfort – carica nel carrello una lista di articoli**
- 🔍 **Cerca ricambi in Cercafacile senza bisogno del log-in**



termostati

termostati di regolazione e di sicurezza

EGO

termostati di regolazione

serie 55.34_



codice	375143	cod. costr.	NTT11C
descrizione	termostato t. mass. 110°C campo di lavoro 32-110°C 3 poli 3NO 16A bulbo ø 6mm bulbo L 138mm lungh. capillare 1480mm isolante sul capillare 1100mm premistoppa M9x1 alb. ø 6x4,6mm alb. L 23mm posizione alberino superiore angolo di rotazione 270°		







accessori per	109515		
	codice	101278	cod. costr. —
	anello bicono per tubo ø 10mm conf. 1 pz		
	codice	101286	cod. costr. —
	anello bicono int. ø 6mm conf. 1 pz		
	codice	101300	cod. costr. —
	ghiera filetto M16x1,5 tubo ø 10mm		
	codice	101450	cod. costr. —
	anello bicono per tubo ø 8mm L 12.7mm conf. 1 pz ø est. 10mm		
	codice	101451	cod. costr. —
	ghiera filetto M16x1,5 tubo ø 8mm		
	codice	110078	cod. costr. —
	manopola senza simbolo ø 70mm alb. ø 6x4,6mm parte piana universale		
	codice	112206	cod. costr. —
	segnalino per manopola argenteo rubinetto del gas PEL21/22/23 t. mass. °C ø est. 63mm int. ø 45.5mm		

rubinetti del gas

PEL

serie 215



codice	109515	cod. costr.	GB1353
descrizione	rubinetto del gas PEL tipo 215 entrata gas flangia del tubo ø21mm by-pass ø 0mm uscita gas M16x1,5 (tubo ø 10/8mm) attacco per termocoppia M8x1 collegamento pilota M10x1 alb. ø 8x6,5mm alb. L 22/15mm parte piana superiore		
ricambi per	109515		
	codice	101060	cod. costr. —
	gruppo magnetico standard L 39mm D1 ø 15.4mm D2 ø 11mm adattabile a PEL20-21/JUNKERS/EGA		
	codice	101206	cod. costr. —
	cappuccio per rubinetti del gas alb. ø 8x6,5mm alb. L 22/15mm parte piana sopra/sotto adattabile a PEL21		
	codice	101230	cod. costr. —
	dado termocoppia F1: M8x1 F2: M18x1 alluminio		
accessori per	109515		
	codice	100908	cod. costr. —
	vite bicono filetto M10x1 per tubo ø 4mm conf. 1 pz		
	codice	100909	cod. costr. —
	vite bicono filetto M10x1 per tubo ø 6mm conf. 1 pz		
	codice	101246	cod. costr. —
	anello bicono per tubo ø 4mm conf. 1 pz		

bruciatori principali



bruciatori piano cottura



bruciatori personalizzati dal costruttore

DELRUE



serie 833





codice	107011	cod. costr.	N/A
descrizione	bruciatore tipo 833 ø 80mm L 120mm		
ricambi per	107011		
	codice	108011	cod. costr. N/A
	spartifiamma tipo 833 ø 78mm		
	codice	108011	cod. costr. N/A
descrizione	spartifiamma tipo 833 ø 78mm		

			
1			
codice	108040	cod. costr.	N/A
descrizione	testa bruciatore aperto tipo 833 ø 80mm		
accessori per	108040		
	codice	108011	cod. costr. N/A
	spartifiamma tipo 833 ø 78mm		

serie 869

			
1			
codice	107002	cod. costr.	N/A
descrizione	bruciatore tipo 869 ø 80mm L 120mm completo		
ricambi per	107002		
	codice	108031	cod. costr. —
	spartifiamma ø 78mm con foro centrale		

			
1			
codice	108040	cod. costr.	N/A
descrizione	testa bruciatore aperto tipo 833 ø 80mm		
accessori per	108040		
	codice	108011	cod. costr. N/A
	spartifiamma tipo 833 ø 78mm		



serie 851

			
1			
codice	107067	cod. costr.	N/A
descrizione	bruciatore tipo 851 ø 120mm L 120mm completo		

			
1			
codice	108017	cod. costr.	N/A
descrizione	testa bruciatore aperto ø 120mm alloggiamento ø 39mm		

manopole

manopole universali

			
1			
codice	110123	cod. costr.	ET1062
descrizione	manopola termostato t. mass. 300°C ø 50mm alb. ø 6x4,6mm parte piana superiore nero campo di lavoro 50-300°C angolo di rotazione 270°		
accessori per	110123		
	codice	110135	cod. costr. NEP1400
	rosetta manopola fino a ø 52mm		

accessori

rosette

			
1			
codice	110135	cod. costr.	NEP1400
descrizione	rosetta manopola fino a ø 52mm		



chiusure

chiusure montaggio laterale

chiusure a leva

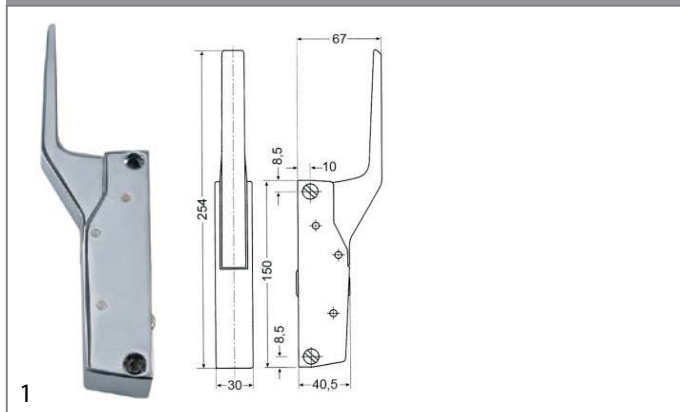
CAFF/FERMOD



codice	700060	cod. costr.	QL1044
descrizione	chiusura a leva L 150mm interasse di fissaggio 133mm senza serratura apparecchi termici G 791		
accessori per	700060		
	codice	700061	cod. costr. —
	nasello per scrocchetto L 58mm lar. 20mm H 35mm interasse di fissaggio 42mm ottone cromato per apparecchi termici		
	codice	700062	cod. costr. —
	protezione per maniglia apparecchi termici		

B

bruciatori piano cottura	3
bruciatori principali	3

C

chiusure a leva	5
chiusure montaggio laterale	5

R

rubinetti del gas	3
-------------------	---

T

termostati	3
termostati di regolazione	3