



Ricambi per Forni & Forni Combinati a Vapore



Ricambi adatti a

ÖZTIRYAKILER

2018

Per la gamma completa sempre aggiornata visitate il nostro internet shop

regolatori di energia

EGO

a singolo circuito



1

codice	380019	cod. costr.	6234.00001.11
descrizione	regolatore di energia 240V 13A circuito semplice senso di rotazione dx alb. ø 6x4,6mm alb. L 23mm filetto di fissaggio M4 rilascio di potenza 6-100% no. 50.57071.010		

termostati

termostati di regolazione e di sicurezza

EGO

termostati di regolazione

serie 55.34_



1

codice	375038	cod. costr.	6234.00001.14
descrizione	termostato t. mass. 300°C campo di lavoro 50-300°C 3 poli 3NO 16A bulbo ø 6mm bulbo L 79mm lungh. capillare 1740mm isolante sul capillare 800mm premistoppa alb. ø 6x4,6mm alb. L 23mm posizione alberino superiore angolo di rotazione 270°		
accessori per	375038		
	codice	110123	cod. costr.
			—
	manopola termostato t. mass. 300°C ø 50mm alb. ø 6x4,6mm parte piana superiore nero campo di lavoro 50-300°C angolo di rotazione 270°		

termostati di sicurezza

serie 55.32_

E·G·O



1

codice	390141	cod. costr.	6234.00001.28
descrizione	termostato di sicurezza temp. intervento 350°C 3 poli 3NC 20A bulbo ø 6mm bulbo L 77mm lungh. capillare 1490mm isolante sul capillare 800mm premistoppa bulbo inox		

interruttori e pulsanti

interruttori/pulsanti basculanti

30x22mm



1

codice	301003	cod. costr.	62320001900
descrizione	interruttore basculante dimensioni di montaggio 30x22mm verde 2NO 250V 16A luminoso 0-1 attacco Faston maschio 6,3mm temperatura ambiente max. 125/55°C protezione IP65		
accessori per	301003		
	codice	301036	cod. costr.
			—
	copritasto dimensione interna 30x22mm per interruttore basculante dimensioni di montaggiomm		



1

codice	301251	cod. costr.	6232.00001.21 7AYS0000136
descrizione	interruttore basculante dimensioni di montaggio 30x22mm verde 2NO 250V 16A luminoso illuminazione attacco Faston maschio 6,3mm temperatura ambiente max. 85°C protezione IP40		

ø20mm



1

codice	348203	cod. costr.	6232.00011.00 6232.00011.28
descrizione	interruttore basculante dimensioni di montaggio 20mm arancione 1NO 250V 4A 0-1 attacco 4,8mm		

 <p>1</p>			
codice	348204	cod. costr.	6232.00011.01 6232.00011.27
descrizione	interruttore basculante dimensioni di montaggio 20mm verde 1NO 250V 4A 0-1 attacco 4,8mm		

commutatori a camme

accesso/spento

 <p>1</p>			
codice	300020	cod. costr.	6254.00005.03
descrizione	commutatore a camme 4 posizioni di comando 2NO frequenza delle interruzioni 0-1-0-1 16A alb. ø 6x4,6mm alb. L 23mm attacco a vite ceramica		
accessori per	300020		
	codice	110135	cod. costr. —
	rosetta manopola fino a ø 52mm		
	codice	110231	cod. costr. —
	manopola interruttore 0-1-0-1 t. mass.°C°C ø 50mm alb. ø 6x4,6mm parte piana superiore nero		

7 posizioni



 <p>1</p>			
codice	300106	cod. costr.	6254.00005.00
descrizione	commutatore a camme 7 posizioni di comando 1NO/2CO frequenza delle interruzioni 0-1-2-3-4-5-6 32A alb. ø 6x4,6mm alb. L 23mm attacco a vite 7 posizioni parte piana superiore		

commutatori ausiliari

 <p>1</p>			
codice	300002	cod. costr.	6254.00005.04
descrizione	commutatore a camme 2 posizioni di comando 4NO 16A frequenza delle interruzioni 0-1 alb. ø 6x4,6mm alb. L 23mm attacco Faston maschio 6,3mm ceramica		

interruttori magnetici

varie

 <p>1</p>			
codice	347961	cod. costr.	6232.00005.10
descrizione	interruttore magnetico 250V 3A P max. 750W 1NO attacco cavo L 12mm lunghezza del cavo 1000mm L1 37mm dimensioni di montaggio 58x13mm H 9mm interasse di fissaggio 49.5mm tensione AC nominale 5A		
Per modelli:	OBK1500		
accessori per	347961		
	codice	699294	cod. costr. —
	magnete ø 20.8mm H 12.5mm int. ø 5mm con vite		

comandi e segnalatori

MOELLER/EATON

blocchetti con contatti

 <p>1</p>			
codice	346292	cod. costr.	6232.00012.05
descrizione	blocchetto di contatti a vite 1NO		

 <p>1</p>			
codice	346293	cod. costr.	6232.00012.07
descrizione	supporto per blocchetto con contatti tripla		



lampade

lampade spia

lampade spia complete

ø10mm

con attacco a vite



1

codice	360649	cod. costr.	6251.00004.10
---------------	--------	--------------------	---------------

descrizione	lampada spia ø 10mm verde 240V lunghezza del cavo 300mm		
--------------------	---	--	--

lampade per forni

lampade per forni universali

diametro di montaggio 35,5mm



1

codice	359718	cod. costr.	62600016006
---------------	--------	--------------------	-------------

descrizione	lampada per forni incasso ø 35.5mm 230V 15W attacco E14 temp. massima 300°C attacco Faston maschio 6,3mm vetro duro		
--------------------	---	--	--

ricambi per	359718		
--------------------	--------	--	--



codice	359701	cod. costr.	—
descrizione	portlampada attacco E14 220-230V incasso ø 35.5mm attacco Faston maschio 6,3mm 15W		



codice	359740	cod. costr.	—
descrizione	lampadina t. mass. 300°C attacco E14 15W 230V ø 22mm L 48mm vetro L 20mm per lampada forno IMPORT 70 1000		

timer

timer meccanici



1

codice	350205	cod. costr.	6259.00002.05
---------------	--------	--------------------	---------------

descrizione	temporizzatore M11 con segnalatore acustico 1 poli tempo 90min azionamento meccanico 1NO a 250V 16A ciclo continuo presente asse ø 6x4,6mm asse 6x4,6mm alb. L 25mm interasse di fissaggio 28mm filetto di fissaggio M4 attacco Faston maschio 6,3mm		
--------------------	--	--	--

Per modelli:	OM20G, OM40G, OM60G		
---------------------	---------------------	--	--

contattori

MOELLER/EATON

contattori di potenza



1

codice	380171	cod. costr.	6230.00014.12
---------------	--------	--------------------	---------------

descrizione	contattore di potenza carico nominale AC1 20A 230VAC (AC3/400V) 9A/4kW contatti principali 3NO contatti ausiliari 1NO attacco collegamento a vite tipo DILEM 10		
--------------------	---	--	--

relè

relè per circuiti stampati



1

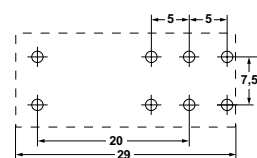

codice	380333	cod. costr.	6231.00020.02 6231.00023.15 6231.00025.07
---------------	--------	--------------------	---

descrizione	relè per circuito stampato 230VAC 2CO a 250V 8A attacco pin distanza fra i puntalini 5mm FINDER codice costr. 40.52.8.230.0000 95.65/95.75		
--------------------	--	--	--

Per modelli:	OBK1500		
---------------------	---------	--	--

accessori per	380333		
----------------------	--------	--	--



codice	380340	cod. costr.	—
descrizione	zoccolo di relè dimensioni 62x36x15mm 250V tensione AC 10A Italiana Relè codice costr. ZMEM/5		



codice	380505	cod. costr.	—
descrizione	zoccolo di relè 2CO 40.52 dimensioni 81,9x15,5x75mm 250V tensione AC 10A FINDER codice costr. 95.95.3		



codice	381181	cod. costr.	—
descrizione	zoccolo di relè 2 poli 40.51/40.52/40.61 attacco morsetti a vite dimensioni 15,8x78,6mm 250V tensione AC 10A FINDER codice costr. 95.75		



elettrovalvole

elettrovalvole per acqua

ELTEK

ELTEK



1

codice	370750	cod. costr.	6262.00008.00
descrizione	elettrovalvola singolo dritta 230VAC entrata 3/4" uscita 11,5mm DN10 t. mass. 90°C ELTEK plastica riduttore di portata entrata blu		
Per modelli:	OBK1500		

ventilatori

motori per ventilatori ad aria calda



1

codice	601503	cod. costr.	5FIR.35011.12
descrizione	ventola D1 ø 350mm H1 125mm pale 12 D2 ø 13mm D3 ø 16mm		
accessori per	601503		
	codice	cod. costr.	—
	motore ventilatore 220-240/380-415V fasi 3 50/60Hz 0,16-0,26kW 1440/1700rpm velocità 2 L1 140mm L2 27mm L3 35mm M10D F 1,2/0,7A Cos(fi) 0.63 tipo L7zAw4D-014 D1 ø 17mm D2 ø 13mm		



valvole del gas e centraline di accensione

valvole di regolazione gas

HONEYWELL



1

codice	106004	cod. costr.	6267.00005.30
descrizione	valvola per gas tipo VK4105C 220-240V 50/60Hz entrata gas flangia 32x32mm uscita gas flangia 32x32mm attacco per termocoppia collegamento pilota campo di pressione 15-60mbar max 60mbar operatore tipo regolaz.press.tipo V5306E 1234 1 adattabile a HONEYWELL int. dei fori 24mm flangia 32x32mm		
accessori per	106004		
	codice	cod. costr.	—
	raccordo gas ad angolo 1/2" flangia 32x32mm int. dei fori 24x24mm Tandem		
	codice	cod. costr.	—
	raccordo gas dritta 1/2" flangia 32x32mm int. dei fori 24x24mm adattabile a Tandem		

centraline di accensione

HONEYWELL



1

codice	102343	cod. costr.	6259.00020.061
descrizione	centralina di accensione del gas HONEYWELL tipo S4565A 2019 1 elettrodi 2 tempo di attesa tempo di sicurezza 10s 220-240V 4VA 50/60Hz		



accensioni e termocoppie















bruciatori pilota



SIT

serie 100



1

codice	106907	cod. costr.	6267.00023.07
descrizione	bruciatore pilota SIT tipo serie 100 3-fiamme ugello \varnothing 0.35mm attacco gas 6mm		
ricambi per	106907		
	codice	100246	cod. costr. —
	ugello per bruciatore pilota gas naturale foro \varnothing 0.35mm conf. 1 pz filetto M8x0,75		
	codice	100855	cod. costr. —
	supporto bruciatore pilota tripla		
	codice	100885	cod. costr. —
	bussola miscelazione d'aria per bruciatore pilota conf. 1 pz		
	codice	100916	cod. costr. —
	molla a compressione per bruciatore pilota conf. 1 pz		
	codice	100917	cod. costr. —
	guarnizione per bruciatore pilota conf. 1 pz alluminio int. \varnothing 8.5mm \varnothing est. 11mm spessore 1.2mm		
	codice	100918	cod. costr. —
	vite per bruciatore pilota		
	codice	107162	cod. costr. —
	testina per pilota SIT 3-fiamme Hmm Lmm conf. 1 pz		
	codice	107702	cod. costr. —
	parte inferiore del bruciatore pilota SIT serie 100 ugello \varnothing 0.35mm		
accessori per	106907		
	codice	100245	cod. costr. —
	ugello per bruciatore pilota gas liquido indice 20 foro \varnothing 0.2mm conf. 1 pz filetto M8x0,75		
	codice	100904	cod. costr. —
	vite di serraggio M10x1 per tubo \varnothing 4mm conf. 1 pz		
	codice	100905	cod. costr. —
	vite di serraggio M10x1 per tubo \varnothing 6mm conf. 1 pz		
	codice	102110	cod. costr. —
	tubo gas accensione rame tubo \varnothing 4mm spessore della parete 1mm L 3000mm		
	codice	102111	cod. costr. —
	tubo gas accensione rame tubo \varnothing 6mm spessore della parete 1mm L 3000mm		
	codice	107171	cod. costr. —
	ugello per bruciatore pilota SIT gas naturale/GPL foro \varnothing 0.25mm conf. 1 pz		

accessori per	106907		
	codice	107700	cod. costr. —
	parte inferiore del bruciatore pilota SIT serie 100 ugello \varnothing 0.25mm		
	codice	107701	cod. costr. —
	parte inferiore del bruciatore pilota SIT serie 100 ugello \varnothing 0.2mm		

cavi di accensione

cavi confezionati



1

codice	100140	cod. costr.	6267.00031.01
descrizione	cavo di accensione lunghezza del cavo 400mm attacco \varnothing 2,4mm / \varnothing 4mm		



1

codice	100019	cod. costr.	6267.00031.05
descrizione	cavo di accensione lunghezza del cavo 900mm attacco \varnothing 2,4mm / \varnothing 4mm		

termocoppie

termocoppie lisce

termocoppie lisce standard

con corpo \varnothing 6(6,5)mm

termocoppie SIT

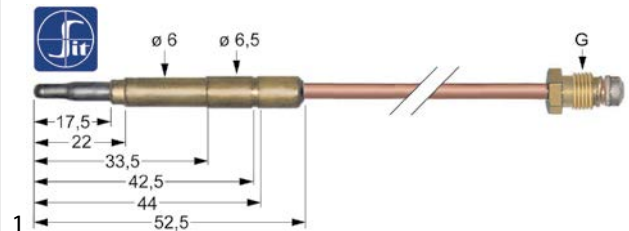

1

codice	107604	cod. costr.	6267.00024.04
descrizione	termocoppia SIT M8x1 L 1200mm attacco ad innesto \varnothing 6,0(6,5)mm		

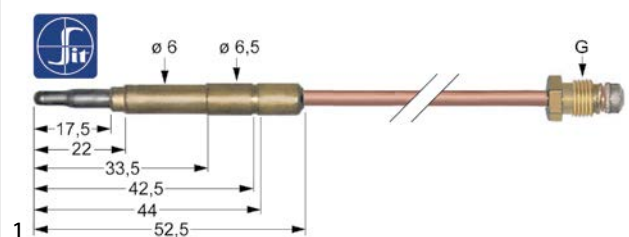

1

codice	107613	cod. costr.	6267.00024.07 T1005191200E
descrizione	termocoppia SIT M9x1 L 1200mm attacco ad innesto \varnothing 6,0(6,5)mm		



guarnizioni

O.R.

EPDM

ø2,62mm

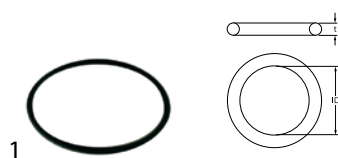

codice	540222	cod. costr.	6228.00059.60
descrizione	O.R. EPDM spessore 2.62mm int. ø 47.3mm conf. 1 pz		

ø5,34mm



codice	510408	cod. costr.	6228.00001.22 6228.00001.26
descrizione	O.R. EPDM spessore 5.34mm int. ø 47mm conf. 1 pz		



codice	510409	cod. costr.	6228.00002.14
descrizione	O.R. EPDM spessore 5.34mm int. ø 56.52mm conf. 1 pz		

organi di trasmissione e cuscinetti

cuscinetti

cuscinetti radiali a sfere 2RS





codice	523522	cod. costr.	6211.00210.01
descrizione	cuscinetto radiale a sfere tipo 6004-2RS albero ø 20mm ø est. 42mm lar. 12mm con guarnizioni cuscinetto radiale rigido a sfere DIN 625-1		
Per modelli:	OM10G		

tubi

tubi flessibili di carico

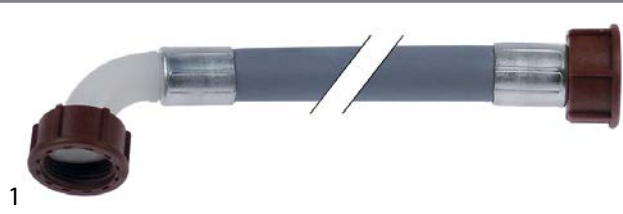
tubi flessibili di carico acqua in PVC



codice	520010	cod. costr.	6262.00021.12	
descrizione	tubo flessibile di carico acqua PVC dritto-curvo DN13 raccordi 3/4" L 1500mm p di lavoro 10bar p di scoppio 32bar t. mass. 90°C blu certificato VDE tenuta piana			
Per modelli:	OBK1500			
accessori per	520010			
	codice	520053	cod. costr.	—
	descrizione	filtro attacco 3/4" D1 ø 26mm D2 ø 15mm conf. 10 pz gomma spessore 8mm		
	codice	520054	cod. costr.	—
	descrizione	guarnizione piana gomma ø est. 23.5mm int. ø 14mm spessore 2.3mm conf. 10 pz		

componenti di fissaggio

viti

vite a testa esagonale



codice	550682	cod. costr.	6262.00003.10
descrizione	vite a testa esagonale filetto M8 lungh. fil. 20mm inox CH 13 conf. 1 pz DIN 933 / ISO 4017		

dadi

dadi esagonali

DIN 985



codice	560143	cod. costr.	6214.00013.15
descrizione	dado esagonale filetto M8 H 8.5mm inox CH 13 conf. 20 pz DIN/ISO DIN 985 autobloccante		



rondelle

rondelle di spessore

varie



1

codice	506160	cod. costr.	6215.00001.03
descrizione	rondella di spessore int. ø 8.6mm ø est. 16mm spessore 1.5mm inox conf. 1 pz		

B			
bruciatori pilota	6		
C			
cavi di accensione	6		
centraline di accensione	5		
comandi e segnalatori	3		
commutatori a camme	3		
componenti di fissaggio	7		
contattori	4		
D			
dadi	7		
dadi esagonali	7		
E			
elettrovalvole	5		
G			
GEV	2		
I			
interruttori e pulsanti	2		
interruttori magnetici	3		
interruttori/pulsanti basculanti	2		
L			
lampade	4		
lampade per forni	4		
lampade spia	4		
lampade spia complete	4		
M			
motori per ventilatori ad aria calda	5		
O			
O.R.	7		
R			
regolatori di energia	2		
relè	4		
rondelle di spessore	8		
T			
termocoppie	6		
termostati	2		
termostati di regolazione	2		
termostati di sicurezza	2		
timer	4		
timer meccanici	4		
tubi	7		
tubi flessibili di carico	7		
		tubi flessibili di carico acqua in PVC	7
		V	
		valvole di regolazione gas	5
		ventilatori	5
		viti	7
		viti a testa esagonale	7